

AM · FM · TELEVISION  
**BROADCAST**  
NEWS

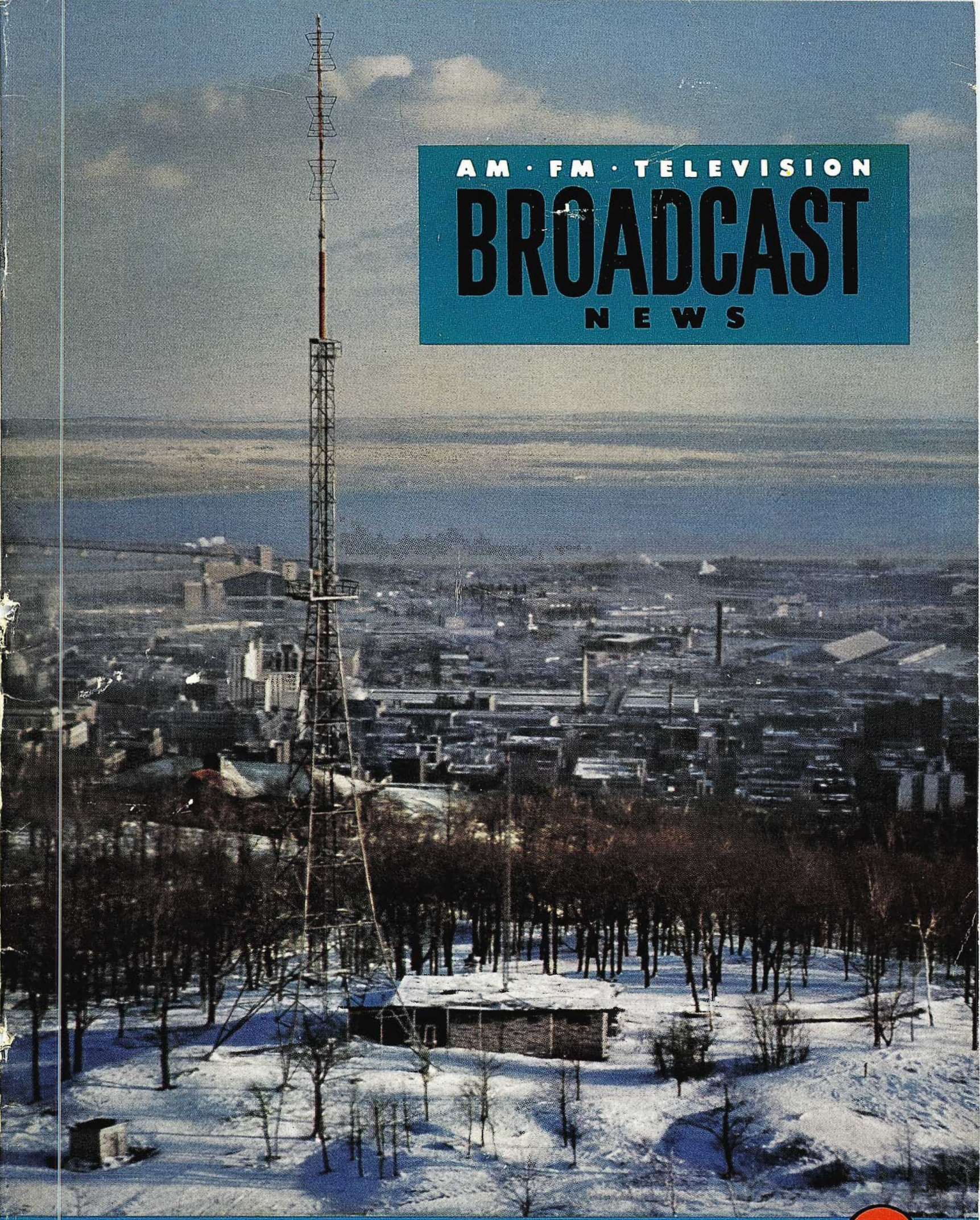

CBFT-TV . . . Canada's First . . . . Pg.8

VOL No. 74

May-June 1953



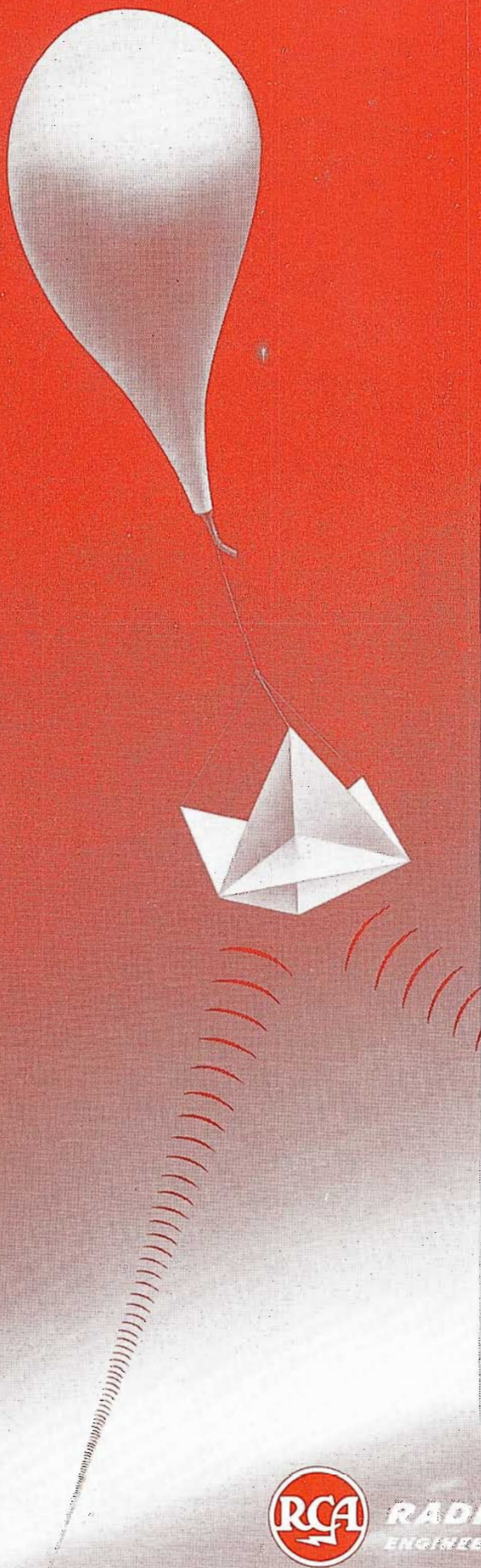

## Which way's the wind blowing?

YOU CAN'T TELL—if you try to track this balloon. Because it's drifting at 40,000 feet—out of sight and beyond the range of optical tracking systems! But a new radar, developed by RCA for the military, can clearly "see" the balloon in any weather—track it accurately—tell how high it is—show how fast it's moving. *Result: Exact wind direction and speed information at specific altitudes!*

Here's how the system works. A free balloon carrying a radar reflector is released. The new RCA ground radar follows the balloon as it rises and drifts with the wind. Signals are reflected back to the radar—accurately directing the movement of the pedestal that feeds data to an electronic computer. From this equipment, wind velocities at specific elevations are presented on teletype to be read on the site, or at some remote point. *All this automatically—and with greater economy than with previous systems!*

"Wind intelligence" like this makes accurate weather forecasts possible—days in advance. It is invaluable in aiming heavy artillery and in directing long-range aircraft and guided missiles! Just one example of how RCA research and applied engineering helps provide our Armed Forces with better electronic equipment. By all means get acquainted with the RCA engineers and field technicians in your Branch of Service.



**RADIO CORPORATION of AMERICA**  
ENGINEERING PRODUCTS DEPARTMENT

CAMDEN, N. J.

# Broadcast News

AM • FM • TELEVISION

Published by the

RADIO CORPORATION OF AMERICA

ENGINEERING PRODUCTS DEPARTMENT . . . CAMDEN, NEW JERSEY

NUMBER 74

MAY-JUNE, 1953

### Subscription Rates

In continental U. S. A. . \$4.00 for 12 issues

In other countries . . . . \$5.00 for 12 issues

JOHN P. TAYLOR, Editor

W. O. HADLOCK, Managing Editor

E. C. MASON, Associate Editor

## Contents

|   |  |    |
|---|--|----|
| CBFT-TV . . . CANADA'S FIRST . . . . .                                  | by R. J. NORTON                        | 8  |
| A TV BUILDING DESIGNED FOR GROWTH, FLEXIBILITY<br>AND ECONOMY . . . . . | by ALLEN R. KRAMER AND EDWIN R. KRAMER | 14 |
| THE TTU-1B, 1-KW UHF TV<br>TRANSMITTER . . . . .                        | by T. M. GLUYAS AND E. H. POTTER       | 22 |
| BUILDING A TV STATION ON A MOUNTAIN TOP<br>(KDYL-TV) . . . . .          | by J. M. BALDWIN                       | 32 |
| THE TP-6A . . . A NEW 16MM PROFESSIONAL<br>TV PROJECTOR . . . . .       | by H. G. WRIGHT                        | 40 |
| NEW 50-KW VHF SUPERTURNSTILES . . . . .                                 | by H. H. WESTCOTT                      | 48 |

Copyright 1953  
Radio Corporation of America  
RCA Victor Division  
Camden, N. J.

218570

TMKS ®

PRINTED  
IN  
U. S. A.

**COVER** of this issue shows CBFT's transmitter installation on Mount Royal, overlooking the city of Montreal. Our good friend Abe Usher, Advertising Manager of RCA Victor Company, Ltd., arranged to have this aerial view made for us so that we could have a cover to go along with our CBFT story on Pg. 8.

**CANADA'S FIRST TV** station is CBFT's proud claim. And we're proud that all of the equipment in CBFT's transmitter installation is RCA, including the 3-bay super-turnstile antenna. Thus RCA is first on the air in Canada, just as it was first in Cuba, first in Mexico, first in Brazil, first in Japan.

**MT. VISION** the site of KDYL-TV's transmitter (see story Pg. 32) is aptly named, we think, even if the title did come after the fact. Sid Fox, president of KDYL and John Baldwin, his engineering v-p, had the TV vision early in the game. In 1947, when television components were hard to come by, John designed and built a 400 watt TV transmitter. It made KDYL-TV one of the first stations in the West. Careful management and careful planning have kept it one of the leaders. Reading between the lines of John's story (Pg. 32) one can easily see the care with which KDYL-TV's superb new installation was made. Another station, on a nearby mountain, was installed quicker and with more ballyhoo. The first heavy windstorm blew it down! KDYL-TV rode out the same storm safely, as it has all those since. Good engineering is vision plus care. On Mt. Vision, good engineering paid off. Congratulations, John, for a fine job!

**JUNIOR CHAMPION** of the TV transmitting industry, is the TTU-1B UHF transmitter described in the article on Pg. 22. The senior champion, of course, is still the RCA TT-5A Transmitter, used by far more stations than any other model of anybody's make. But the new TTU-1B—only four months old (counting from first shipment)—is coming up fast. With nearly forty shipped, and probably about thirty on the air when you read this, we believe it is already the second most widely used TV transmitter model. Considering how hard everyone thought UHF would be, things are coming along fine. And want to know something else? These little 1-kw's are getting out better—a whole lot better—than the long-haired experts predicted.

**AT THE NARTB**, where many of you will first see this issue, we will as usual be showing almost everything imaginable in new equipment—especially TV equipment. Some of the things we recommend for your attention are:

**A COMPLETE TV STATION IN OPERATION** (except for r-f on the air). This should be a must for telecasters who have not yet ordered equipment. It includes a 1-kw UHF transmitter, racks containing all of the necessary audio, video and monitoring equipment, complete film setup, one live camera with monitor, and auxiliary equipment. This is the famous "RCA Basic Buy", already installed by thirty some stations. Here's your chance to see exactly what it contains.

**A NEW 10-KW VHF TRANSMITTER** will also be on display. This is our brand new TT-10AL, on view for the very first time. We feel that this transmitter, for which we (and many of you) have waited a long time, will become, during the next two years, the most popular of all VHF transmitters—the new VHF champ (see above). We believe that, like the TT-5A, it will be the standard against which all TV transmitters will be compared.

**A REALLY NEW PROJECTOR**, the TP-6A (see article on Pg. 40) will also be on display. This is not a re-vamp of an older model. And it is not a modification of a standard film projector. It is a projector of entirely new design (new "from the gate up"). And it's entirely out of the class of all previous 16mm TV projectors, a really professional job. The first—and only—professional-type projector designed specifically for television. But don't take our word for it. Come see it for yourself, in the Renaissance Room at the Biltmore.

# The only

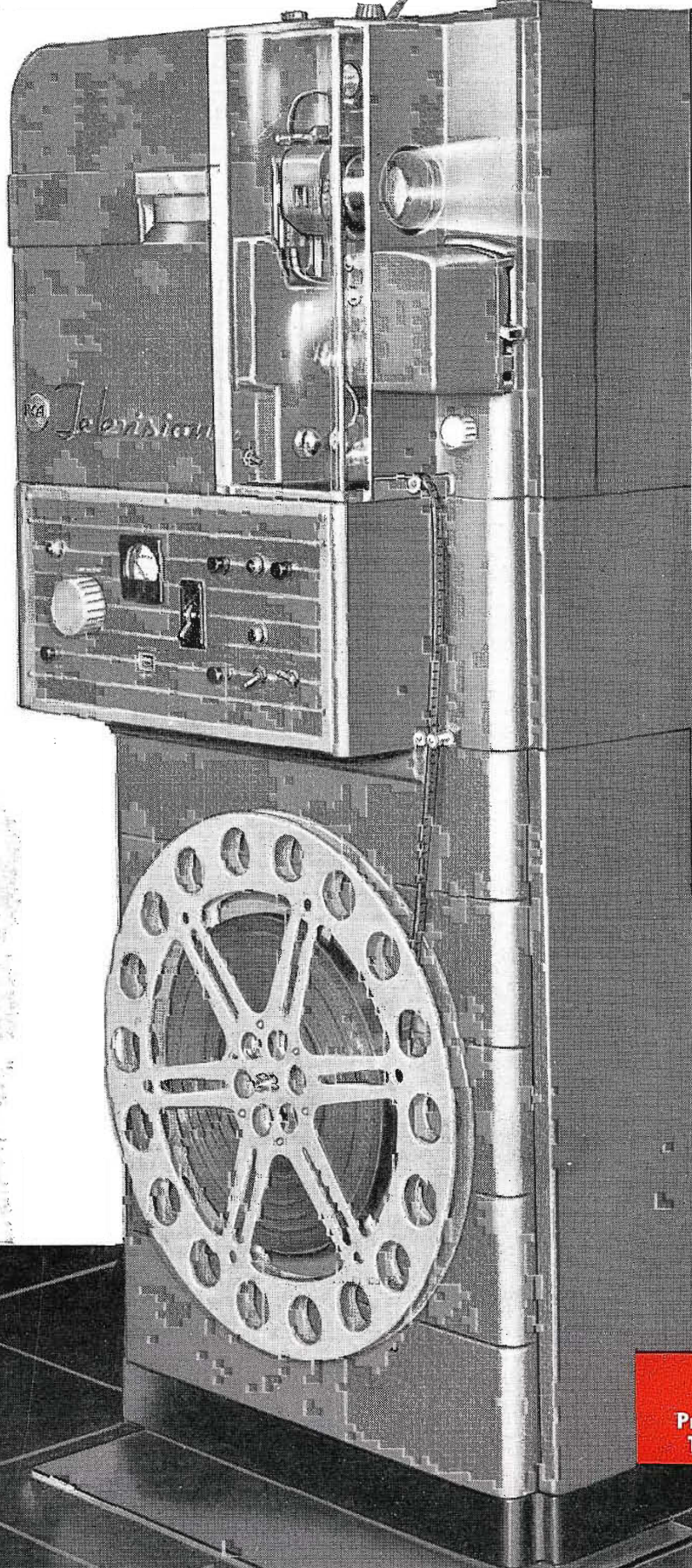

● 2-3 claw with jeweled tip assures long life

● Changes projection lamp *automatically*

● Dual focus controls

● New precision optical system—f 1.5 projection lens with "built-in" infra-red filter

● Handles 4000-ft. reels—compensated "take-up" provides constant tension

● "Still frame" projection with 2-second stabilization of picture and sound

● Framing without image displacement

● Framing and motor hand-turnover controls accessible from either side

● Instantaneous exciter lamp change . . . lever operated!

● Everything unit-built for easy maintenance

**RCA**  
**Type TP-6A**  
**Professional 16mm**  
**TV Film Projector**

# professional 16 mm film projector

*...specifically designed for television!*

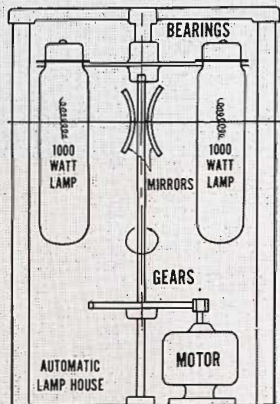

Automatic projection lamp change—takes less than a second!

HERE IS A professional equipment that fits television film standards exactly . . . the new RCA 16mm Film Projector Type TP-6A. It is designed to meet every requirement of the TV station looking for the best picture quality possible from 16mm film.

Unlike standard 16mm projectors now available, the TP-6A is newly engineered from "base-to-reels." New  $f/1.5$  lens, new framing system, new dual focus arrangement, are among the features that contribute to its outstanding picture quality. New broadcast-

quality amplifier assures high-quality sound. New 4000-foot reels (with compensated take-up), new 2-3 claw intermittent in oil, and new automatic lamp change-over, combine to provide unsurpassed operating convenience and film-show reliability.

*For a vast improvement in 16mm picture quality—nothing approaches the TP-6A. Check the 10 important features at the left.*

**For more details** and delivery information call your RCA Broadcast Sales Representative.

## An outstanding example of design simplicity

"See-through" Lucite door panel

Full inch clearance between aperture plate and lens gate

Simple film path

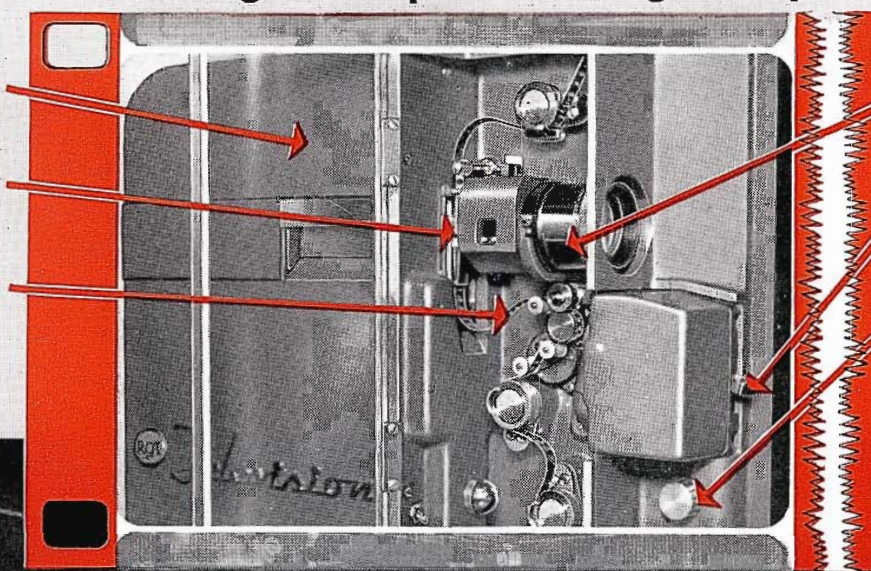

$f/1.5$  projection lens

Lever for exciter lamp change-over

Focus control—front and rear



**RADIO CORPORATION of AMERICA**  
ENGINEERING PRODUCTS DEPARTMENT  
CAMDEN, N. J.

# UHF Pylons

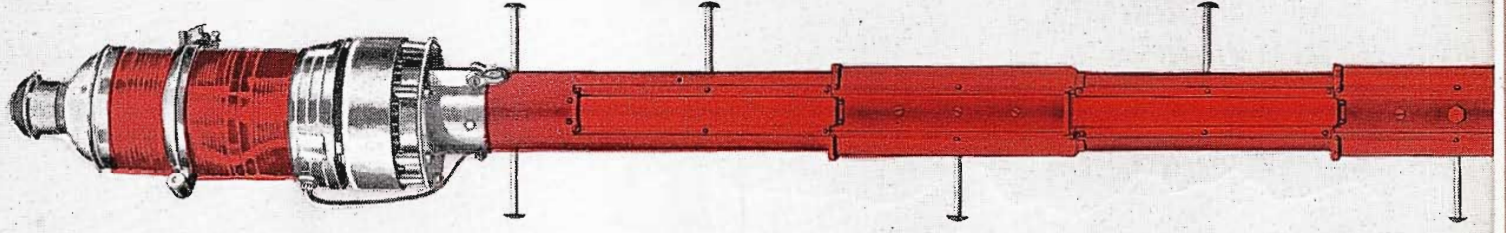

## Adjustable Beam, High-Gain TV Antennas

### Check these 9 features

#### Any power to 1000 KW

RCA UHF Pylons have ratings suitable for any transmitter power up to 50 kw... and for an ERP (Effective Radiated Power) up to 1000 kw.

#### Power gains up to 27

RCA UHF Pylons can be furnished with gains in the order of 3, 6, 9, 12, 21, 24 and 27.

#### Adjustable beam tilt

The "Beam Tilt" of the RCA UHF Pylon is a "built-in" feature. Easily adjusted in the field, you are assured of best possible coverage and maximum vertical pattern reinforcement. Mechanical "beam tilt" by leveling plates—electrical "umbrella" effect by sliding transmission line fitting.

#### Near perfect circularity

With the RCA UHF Pylon, you get equal signal in all directions. The measured and theoretical patterns are within 1% of a perfect circle!

#### No protruding elements

Nothing "sticks out" from the RCA Pylon. The smooth surface of the pipe itself is the radiator. There's nothing to bend or break under ice or wind load.

#### No tuning adjustments

The RCA UHF Pylon is "custom tuned" for your frequency—in the RCA plant. You put it up, connect the line, and throw the switch! Absolutely no tuning required.

#### Null fill-in

High-gain antenna measurements show the first null filled in about 10%—satisfactory for

all except unusual mountain top locations. See the curves below.

#### Special matched transmission line

No UHF antenna will function properly unless the transmission line closely matches the antenna. RCA supplies *specially designed* lines, not available anywhere else. Factory tests on this line show VSWR better than 1.05 to 1.0.

#### Complete accessories available

RCA can supply transmission line fittings, towers, directional couplers, signal demodulators, UHF loads, wattmeters, filterplexers—all *specially designed* to work with the UHF Pylon.

**REMEMBER!** Only by having *everything* matched from transmitter to antenna can you be sure of results. Why take a chance? Call your RCA Broadcast Sales Representative.

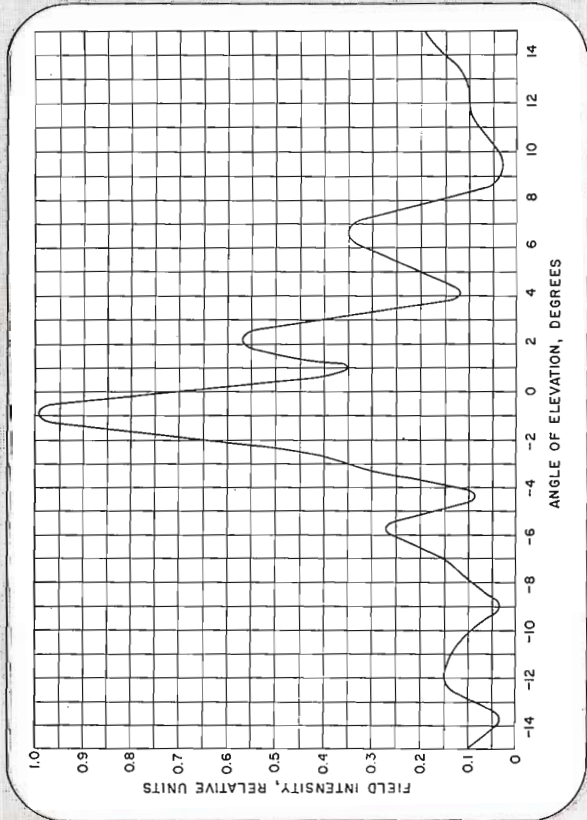

Typical measured vertical field pattern of a UHF Pylon. Phasing adjusted for 0.92° pattern tilt.

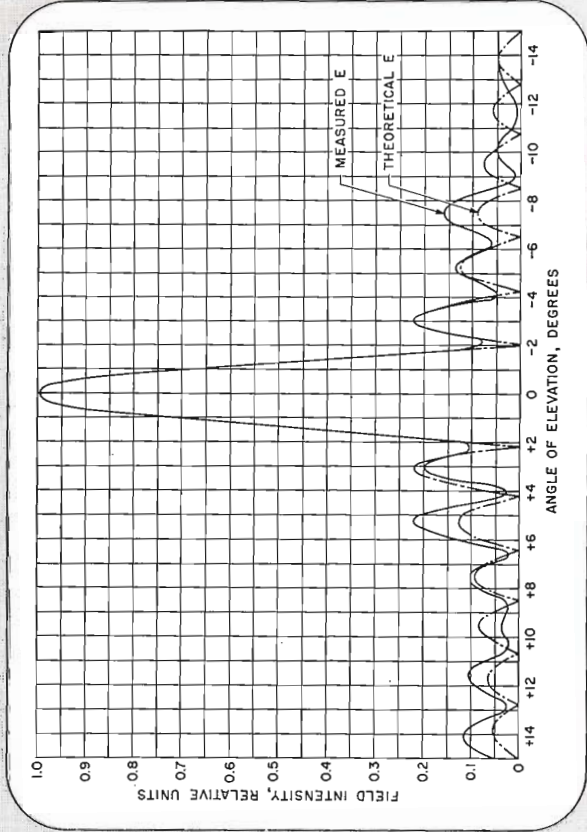

Typical calculated and measured vertical field pattern of a UHF Pylon. Channel 75 (838 Mc).

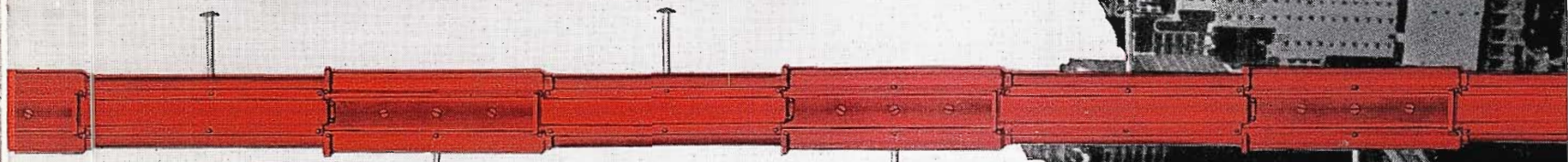

RCA's UHF Pylon

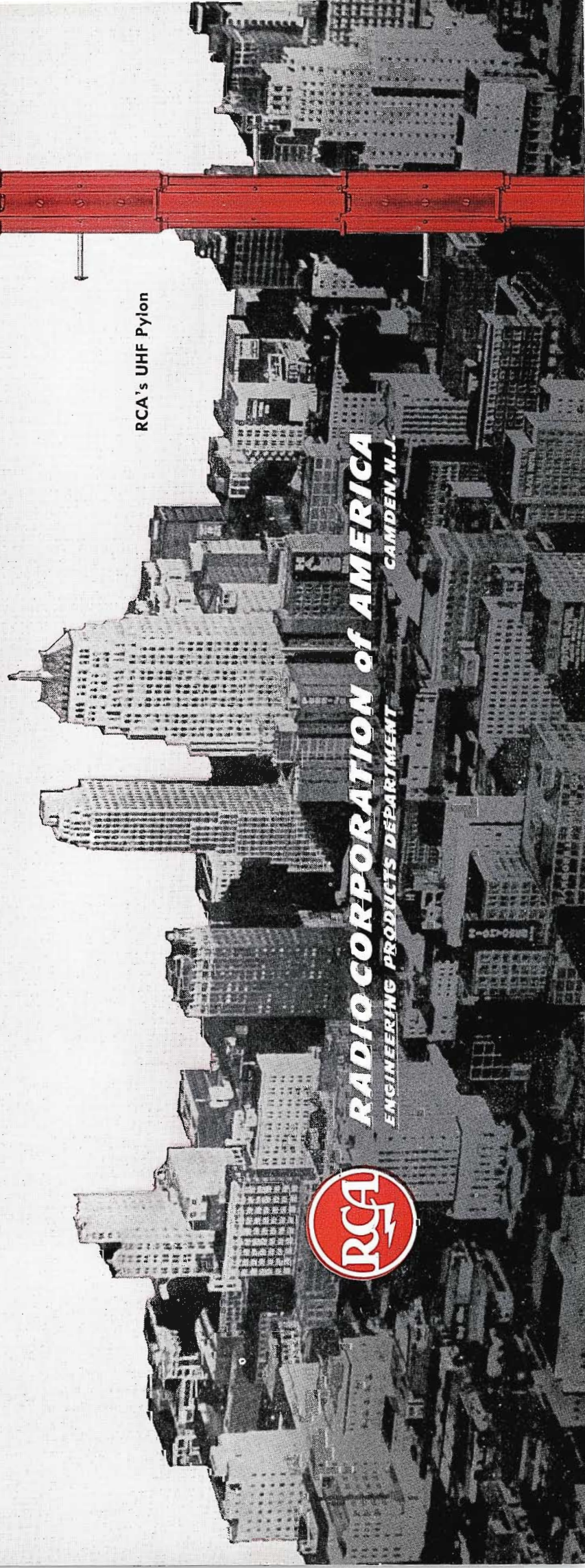

**RADIO CORPORATION OF AMERICA**  
ENGINEERING PRODUCTS DEPARTMENT  
CAMDEN, N.J.

# *Centralized Control...* **with**





# "tailored" switching and monitoring

**TC-4A Control Console combines Audio-Video Switching with Transmitter Control—makes it possible to centralize all operations at one position**

Now you can do all (or any desired part) of your audio-video switching *right in your transmitter room . . .*

And you do not have to take a fixed group of units to do it. You can have whatever group of audio and video facilities you need to fit your particular requirements. Moreover, you can add further audio and video facilities as needed.

You get this economy and flexibility by building your equipment layout around the new TC-4A Control Console. The TC-4A is a two-section unit containing basic switching facilities for handling up to 8 audio and 8 video signals (remote or local). It can fade to black and "program-switch" network, remote, film, and local studio signals. Up to twelve signals can be monitored including transmitter operation.

To this two-section unit you can add as many console sections (for "on-air" monitor, preview monitor, individual camera monitors) as you need to take care of your individual requirements. In this way you can build up a "centralized" control position from which one man can (if necessary) perform all operations.

Moreover, you do all of this with standard RCA units exactly like those used by the largest stations and the networks. Thus, if you decide later to expand to a multiple studio layout you can very easily rearrange these same units for that type of setup.

Remember . . . in TV it's good business to buy the best to begin with.

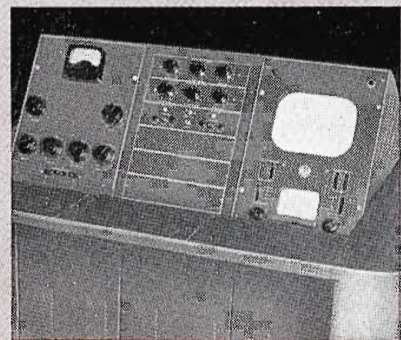

The basic TC-4A (left-hand and center sections) with a master monitor (right-hand section) as normally used at the transmitter (i.e., no video origination at this location).

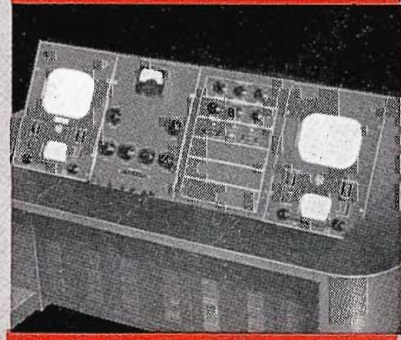

The same setup with a film camera control unit added (at the left) for programming of slides and films from the transmitter—or for small stations without "live" studios.

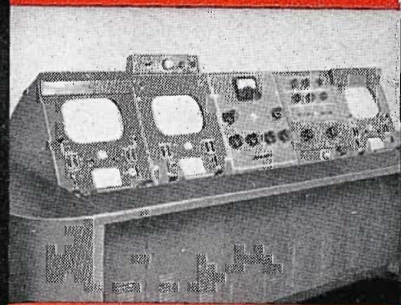

Similar setup with two camera control units (one live and one film, or two film), such as used in the RCA "Basic Buy" for TV.

TC-4A Control Console (3rd and 4th units from left) combined with three monitor sections to provide complete station operating control from a position in the transmitter room. In this arrangement the first unit of the console (starting from the left) is the "live" camera control and monitor, the second is a film camera control, the third unit contains audio faders and audio and video switching, the fourth unit contains monitor switching and remotely located equipment controls, the fifth unit is the line master monitor. Audio and video amplifiers, power supplies, etc., are mounted on the racks at left (shown shaded). The transmitter in the background is the Type TT-2A 2 kw, VHF TV Transmitter. However, the same arrangement of controls and audio-video facilities can, of course, be used with any RCA TV transmitter, UHF or VHF, 500 watts to 50,000 watts (providing ERP's of 1 kw to 1000 kw).

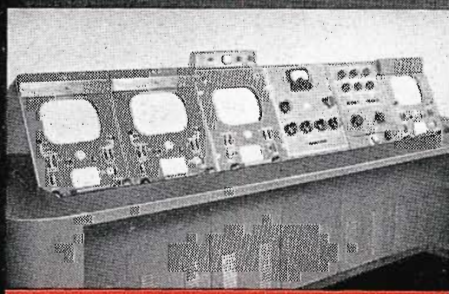

TC-4A with master monitor unit, preview monitor unit, and two camera control units (one live and one film or two film). If desired, sections can be arranged U-shape or L-shape to fit available space.



**RADIO CORPORATION of AMERICA**  
ENGINEERING PRODUCTS DEPARTMENT  
CAMDEN, N. J.

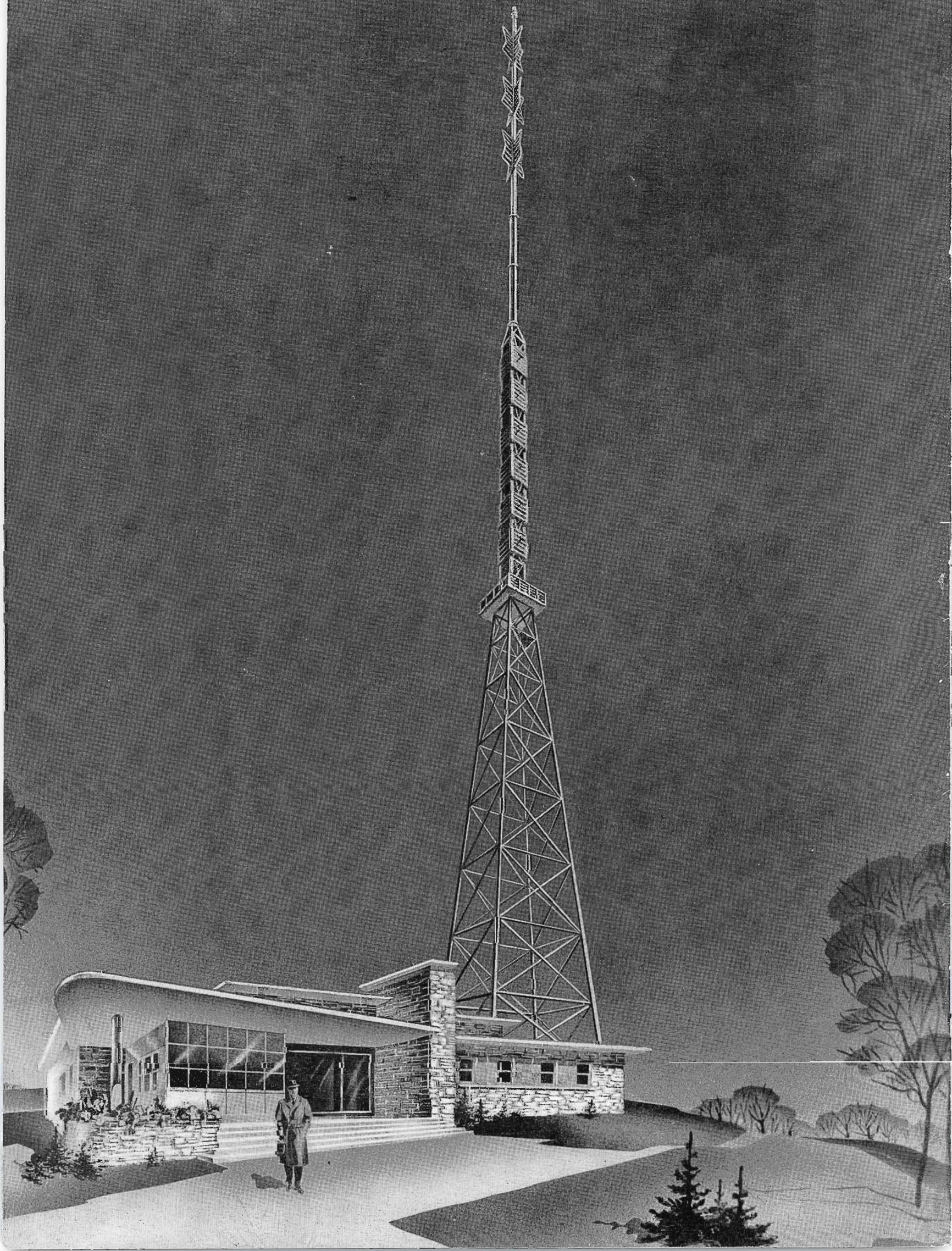

# CBFT-TV . . . CANADA'S FIRST

**By R. J. NORTON**  
Engineering Products Division  
RCA Victor Company, Ltd.  
Montreal, Quebec

At 3:42 PM, E.D.S.T. on June 2, 1952 the first modern television transmitter in Canada went on the air. Montreal's CBFT of the Canadian Broadcasting Corporation had begun telecasting the RCA standard test pattern on channel 2. These first telecasts complete with musical recordings originated entirely from the transmitter location on the top of Mount Royal, the mountain park in the centre of the city. The mountain, which is in the centre of the more thickly populated part of greater Montreal, consists of three peaks—Mount Royal, Westmount, and Outremont.

In order to determine the most suitable peak on which to locate the transmitting site a survey was carried out by the Transmission and Development Department of

the Canadian Broadcasting Corporation. The distribution of population coupled with the shadowing effect of one mountain on the other, narrowed the choice of sites to Outremont and Mount Royal. An extensive survey was then carried out from the most prominent and highest point on each of these peaks.

A small transmitting station was set up successively at each site. The transmitter, built by the C.B.C., had facilities for pulse modulation in order that reflections could be investigated. The antenna consisted of a two-bay stacked dipole on an eighty foot mast. The receiving equipment, consisting of a field intensity meter, special preamplifier, automatic recording equipment and an oscilloscope for ghost investi-

gation, was mounted in a car. Tests were carried out at a frequency of 61 mcs.

It was found that the site on Mount Royal was more suitable than that on Outremont Mountain. This site is 744 feet above sea level. Negotiations lasting approximately a year were then begun with the city of Montreal to secure the site on top of Mount Royal.

Meanwhile the Engineering Division of the C.B.C. had been busy with the design of the station facilities. The transmitter and antenna installation and supply were awarded to RCA in 1950. The Engineering Products Department of RCA Victor in Montreal planned these installations and supplied the necessary information to the

FIG. 1 (left) and FIG. 2 (below). RCA-equipped TV station CBFT—Canada's first television station, situated atop Mount Royal, overlooking the city of Montreal. Transmitter building architecture has chalet appearance, specified by civic authorities as a desirable style for public park in which it is located.





FIG. 3. Two-section heavy duty Pylon passing microwave platform. Constant cross-section of tower from this point to the top is for channel 6 Supergain Antenna.

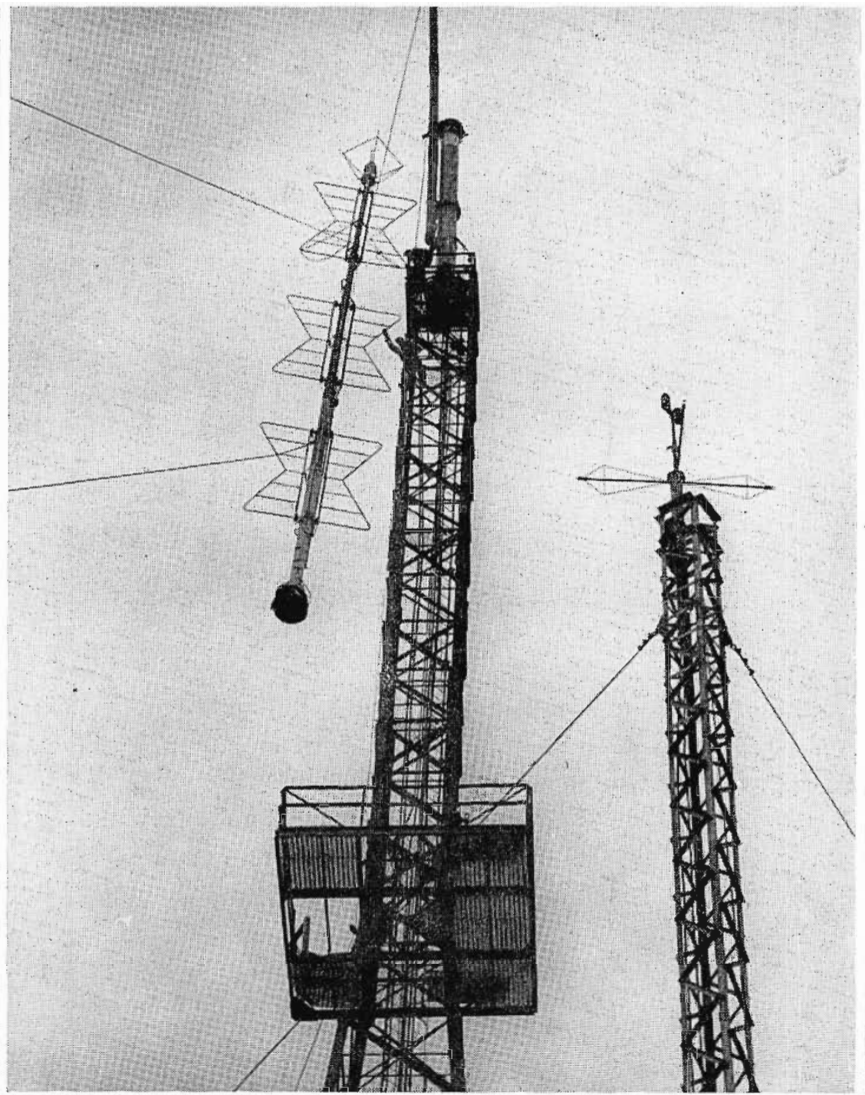

FIG. 4. The RCA TT-3B Superturnstile Antenna nearing the top of the tower. The temporary antenna can be seen at the right, foreground.

C.B.C. in order that the design of the transmitter building and the antenna supporting structure could be completed.

The Architectural Department of the C.B.C. were faced with unusual problems in the design of the transmitter building. Owing to the location in a public park, there was limited space available and the civic authorities specified that the exterior of the building must have a chalet appearance in keeping with the nature of the park.

The building is of reinforced concrete construction. The exterior walls are of cut stone and granite finish. A large picture window is provided in the front. This allows the public to view control room operations. Two console type receivers are located by the window for the convenience of onlookers.

Space has been provided in the building for a future TV transmitter which will

operate on channel 6, and for two existing FM stations, CBM-FM and CBF-FM which are scheduled to be moved up to the building from their present location in downtown Montreal around the middle of January, 1953. Living quarters are also provided for the operational staff in the advent they are isolated by a heavy snow-storm. These quarters include a modern kitchen, bedroom and complete toilet facilities. An automatic oil heating system, an incinerator and complete ventilating facilities for the electrical equipment have been provided. The major components of these systems are located in the basement of the building which is divided into various rooms.

Primary power is brought up to the transmitting site at 2,400 volts, 60 cycles, three phase. The necessary transformers and switchgear for supplying the various building loads are located in a transformer room in the basement. Metering facilities

are provided to check the incoming lines and the power requirements of the outgoing circuits.

The incoming cable from the studio is terminated in a terminal equipment room in the basement. The cable and equipment were provided by the Bell Telephone Company of Canada. There are 16 high quality program pair for audio and 6 video lines directly between studio and transmitters.

The electrical installation was the responsibility of the Plant Department of the C.B.C. Insofar as the transmitter and associated equipment was concerned, RCA Victor engineers supplied typical installation drawings for the TT-5A transmitter and associated equipment showing the space and duct requirements for the equipment and planned the installation well in advance down to the last nut and bolt. The inside transmission line interconnecting transmitter, sideband filter, diplexer

and the 90° phasing section, was cut in advance. Specifications for the location of hanger rods for the ceiling mounted side-band filter, WM-20A demodulator, diplexer and transmission line, were supplied in order that these rods could be anchored in the concrete roof during construction of the building.

A block diagram (Fig. 7) shows the equipment used at the transmitter.

The standard RCA input and monitoring equipment racks, (MI-19203) were used except that the WM-20A Picture and Waveform Demodulator replaces the WM-12A and WM-13A. Two more racks are also in use; and RCA type TG-1A studio sync generator and the other containing an RCA Monoscope Camera, Grating Generator, Video Sweep Generator, Distribution Amplifier and a 580-D Power Supply. No switching facilities other than

via jack fields are provided at the transmitter since all program switching takes place at the studios located in the C.B.C. building on Dorchester Street in downtown Montreal. The only exception to this is when the station goes to test pattern from programming or vice versa. In this case the test pattern originates at the transmitter and switching is via the video jack panel. It is also possible to transmit a grating pattern from the transmitter location.

The antenna supporting structure (see Figs. 1, 2, and 3) was designed to support four antennas. It is a self supporting structure as can be seen from the accompanying photographs. The base of this tower is 45 feet square and rises to a height of 198 feet, 11 inches. The platform which can be seen is at the 129-foot level and is for micro-wave relay equipment. A small winch is located on the platform for hoisting up the micro-wave equipment when its

use is required. The tower from this point to the top is of constant cross-section and is designed to support a channel 6 RCA supergain antenna. A two-section RCA heavy duty Pylon antenna sits on top of the tower. Each section is used independently. One is used at 100.7 mcs for CBM-FM and the other at 95.1 mcs for CBF-FM. On top of the Pylons is the three-section RCA type TF-3B, Superturnstile for CBFT. The transmission lines, two for the Superturnstile and two for the Pylons are copper, 1 $\frac{5}{8}$  diameter line. Dry air is used to pressurize the lines. Information was supplied to the C.B.C. in order that mounting holes for the transmission line hangers would be provided in the tower during fabrication. The lines run down the centre of the tower with special members being provided where required in order to bring the lines to their central position. Spring hangers are used except for the very

FIG. 5. A closeup view of the lightning protector arrangement which was built on the standard beacon mounting flange. Emile Racine of Racine Tower Construction, who assembled and erected the antennae, is shown at right with one of his men.



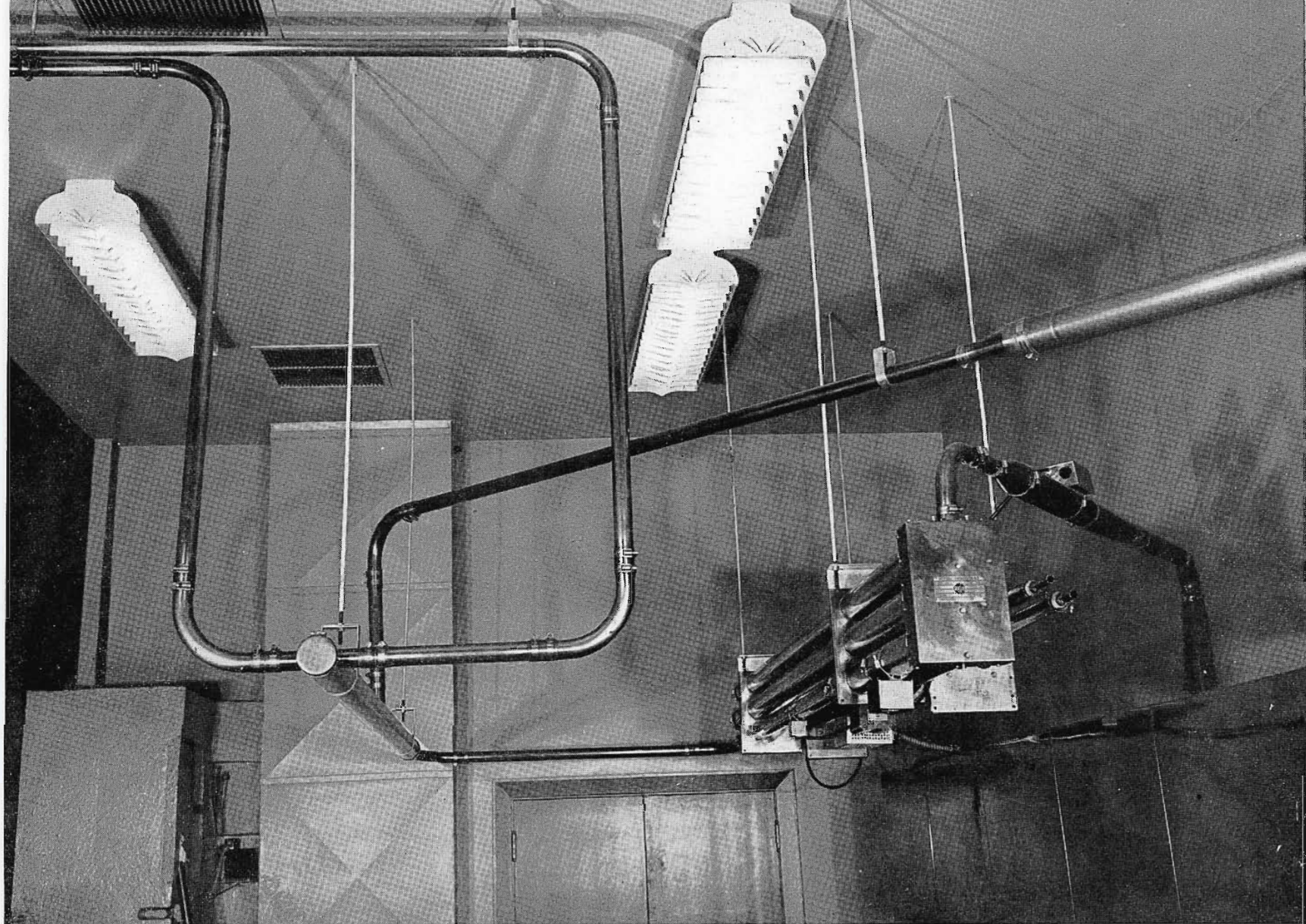

FIG. 6. Rear of transmitter showing diplexer, sideband filter, WM-20A Demodulator and inside transmission line. The line passes through the building wall just to the left of the picture. Gassing takes place just prior to leaving the building. One line is 90° longer than the other from the output of the diplexer to the upper left corner of the picture.

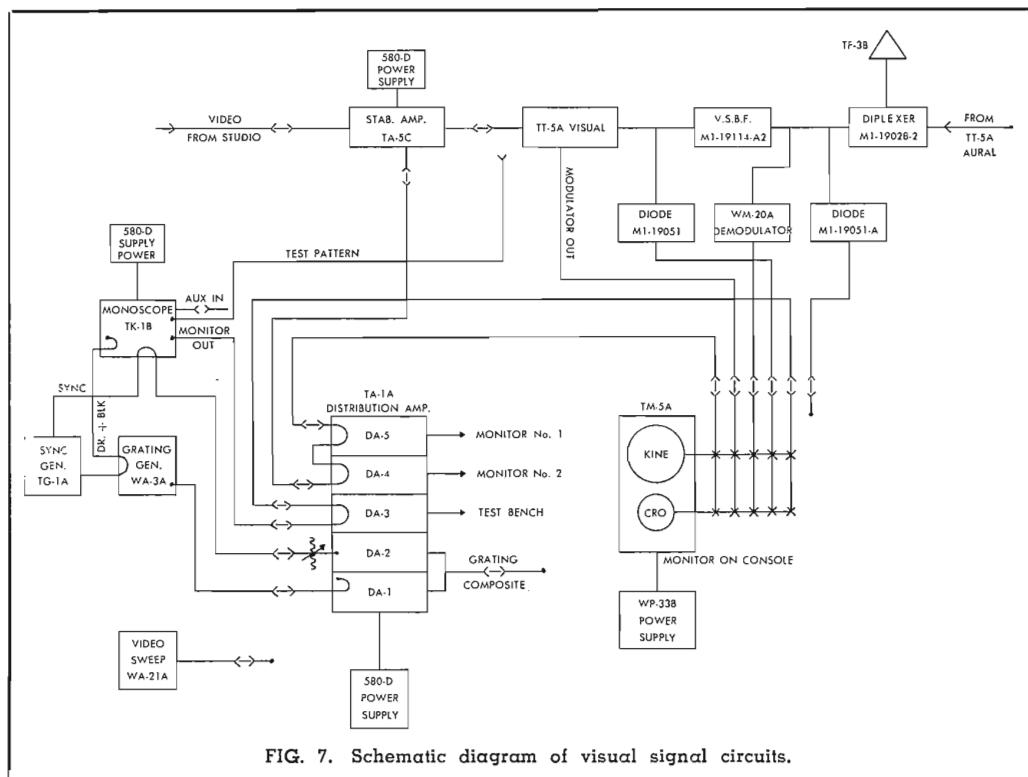

FIG. 7. Schematic diagram of visual signal circuits.

top of each run where fixed hangers are used in order to anchor the lines.

Actual construction of the transmitter building began in the summer of 1951. The excavation for the building had to be literally blasted out of solid rock. Thus it was not until April 7, 1952 that the building had reached the stage where the equipment could be moved in and the installation started. Before this it became apparent that due to a shortage of steel the tower would not be ready until the Autumn of 1952. Since the C.B.C. was more or less committed to go on the air before the Fall, a temporary antenna seemed to be the only solution. Bruce Mackimmie, antenna specialist at RCA Victor, Montreal, designed and built one from scratch and had it ready for the initial telecast on June 2, 1952. A temporary eighty-five foot tower

was installed on top of the transmitter building. This temporary antenna and tower can be seen in Fig. 4. This antenna consists of a pair of crossed broadband dipoles, arranged in turnstile fashion and fed with quadrature currents. Special transmission line transforming sections are used to give a broadband impedance match at a pair of coaxial terminations at the feeding terminals.

The coaxial link between studios and transmitter was completed by July 15, 1952. On July 24, 1952 the first study program was telecast. This was a film. Shortly afterwards, telecasting of the local ball games began. These first programs were listed as experimental telecasts. Formal opening of CBFT took place on September 6, 1952. Formal delivery of the transmitter was made by F. R. Deakins, President, and J. B. Knox, Engineering Products Manager of RCA Victor, Canada and was accepted by Alphonse Ouimet, C.B.C.

General Manager and J. E. Hayes, Chief Engineer.

Around the middle of October a new landmark began to appear on top of Mount Royal. This was the TV tower and by the end of October it was completed. The Superturnstile and Pylon antennas were moved up from their storage space at RCA Victor Plant in Montreal for installation. The assembly and erection of these antennas was completed by the end of November and CBFT began transmitting from their Superturnstile on December 4, 1952.

The RCA Service Company checked out the antennas. Coverage which was remarkably good with the temporary antenna has of course improved with the higher gain and height of the permanent antenna. Good signals are received consistently in the northern portions of New York and Vermont States near Montreal.

At the present time, programming is limited to from two to three hours in the evening starting around 8:00 P.M. There is a Children's program usually from 5:30 P.M. to 6:00 P.M. Exceptions to this are Sunday afternoon telecasting from about 2:00 P.M. to 6:00 P.M. and the regularly scheduled women's programs from 3:00 to 4:00 on Friday afternoons. The majority of shows are in French since the area around Montreal is mostly French speaking. Agreements have been made by the CBC with NBC, CBS and Dumont networks for the use of some American material. In Montreal this is via kinescope recording, however, a Bell Telephone TD-2 microwave relay is scheduled for completion around May 1953 connecting Buffalo-Toronto-Ottawa-Montreal making it possible to tie into the major U. S. networks. CBFT will, however, continue to originate most of its own programs because of its obligations to the French population.

FIG. 8. CBFT Technician, Roland Berube, checking TT-5A Modulation. The test pattern can be seen as the picture was taken between the end of the Children's 5:00 to 5:30 P.M. Program and the start of the evening telecasts at 8:00 P.M.



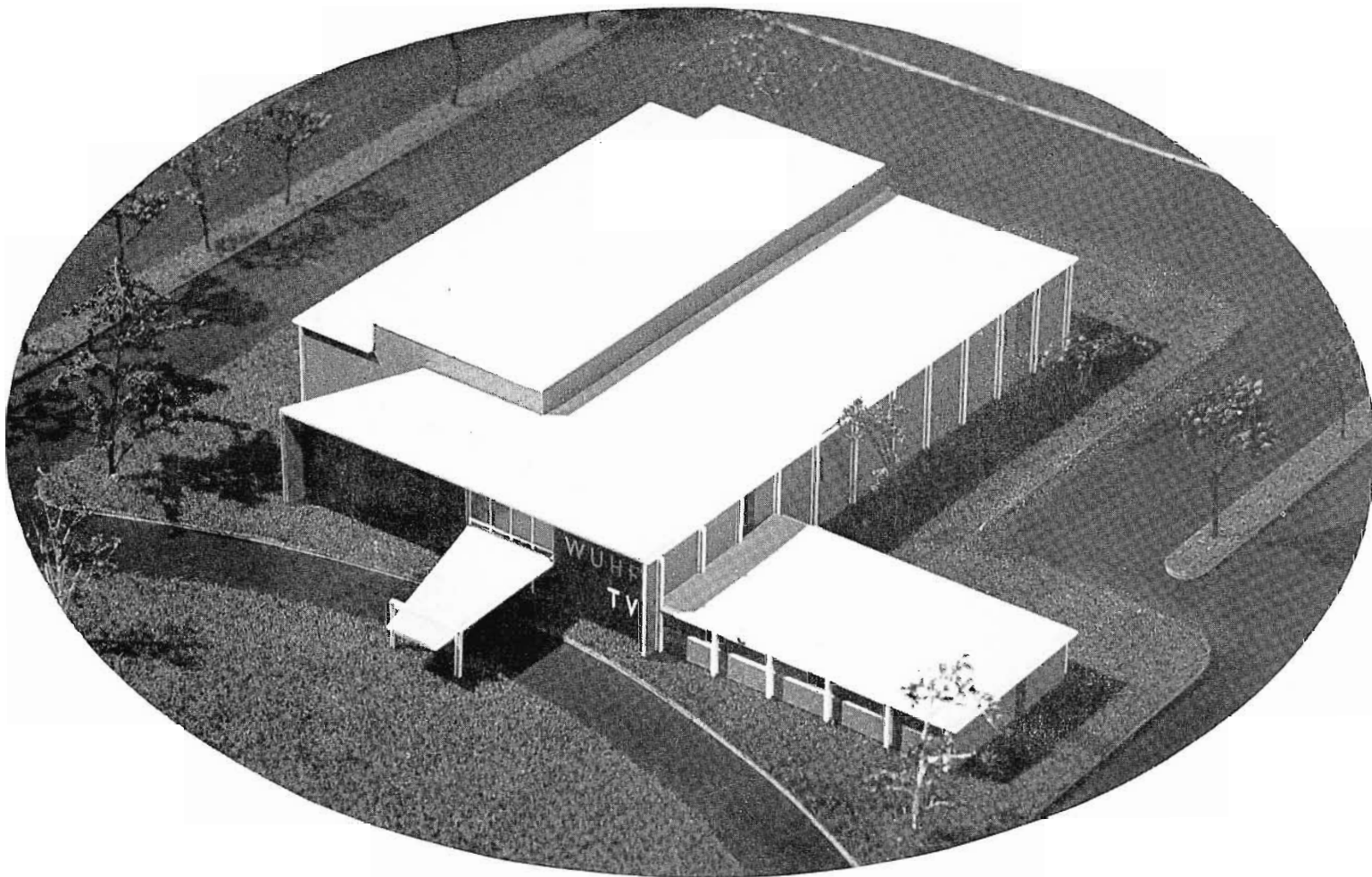

FIG. 1. Overall view of completed radio-TV building.

# A TV BUILDING DESIGNED FOR GROWTH, FLEXIBILITY AND ECONOMY

**A Practical, Master Plan for the Organized Step-by-Step Development of a Typical Radio and Television Station Located in a Medium-Sized Community**

by  
**ALLEN R. KRAMER**  
 and  
**EDWIN R. KRAMER**  
 Kramer, Winner & Kramer  
 Architects and Engineers

Aside from certain legal and financial considerations, the first step in the design of a building should be the selection of a site. Site selection is noted as a design step because the site determines as much about the form of the building as any other single factor. The size of the site may determine whether a single or multi-story scheme may be used. Conformation of the land,

the presence of rock or water, availability of utilities, relation to adjacent buildings, and sources of noise are a few of the physical factors to be considered. No site should be purchased without the help of the architect who is going to design the building. It is also important to consider the following: accessibility, advertising and public relations value, and tax rates.

Site requirements are much more complex than one is inclined to accept, before an analysis has been made. If it is financially possible, it is wise to buy at once a piece large enough for all future requirements. The attempt to buy an adjacent piece of land at a later date may be unsuccessful or may cost two or three times the original land cost. It is generally be-

lieved by laymen that TV is a magic world where limitless funds are available and any price will be paid. It is wise to buy once, buy enough, and buy anonymously.

The subject of antenna location in relation to the broadcast area and to the station itself is a distinctly separate problem which is so dependent upon local conditions that it will not be considered at this time.

There is one word which has become rather commonplace in a discussion about the future of TV. That word is *expansion*. Everyone agrees that expansion will be necessary, but there is a concept which is mentioned less frequently and which is even more important. That concept is *flexibility*,



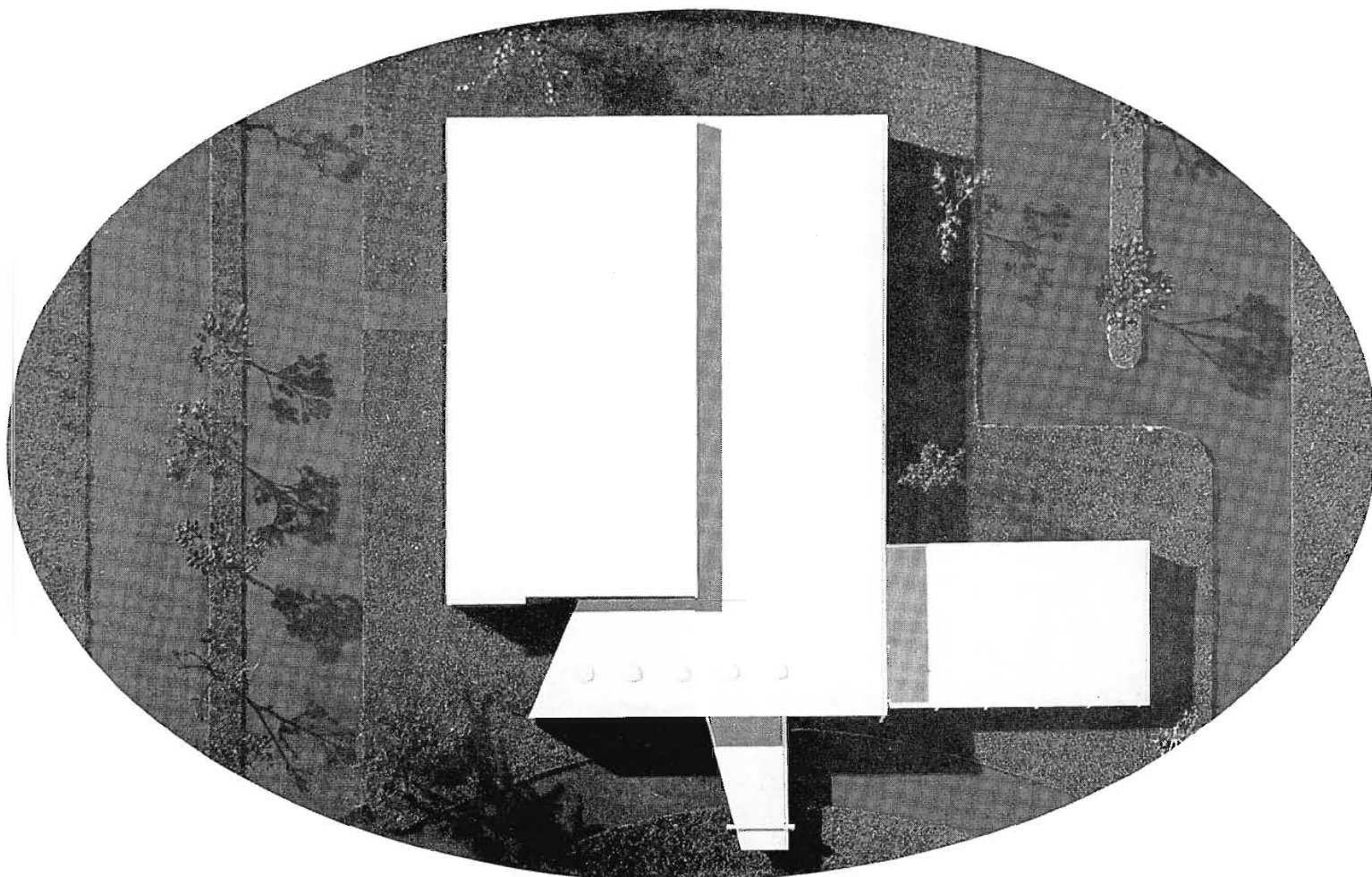

FIG. 2. Top view of radio-TV structure.

and it implies not only the possibility of a variety of expansions, but the rearrangement of existing facilities to form totally new plans. This brings us to the question of predictability of the future of TV. We cannot be certain about such factors as the proportion of film to live shows that will be required to arouse regional interest and satisfy regional pride.

Our views are based on the assumption that live shows will be required to provide local interest in a station and also that some public service programs must be live; that some form of studio audience will always be required for certain types of entertainment; that radio will depend to an increasingly greater extent upon recorded material.

Because one's entire thinking in the planning of a TV station should be oriented toward the ultimate scheme, it seems appropriate that we should start with a description of the final stage of growth and work back to the earlier stages.

In Fig. 1 we have an overall view of the completed radio-TV building, and in Fig. 2 a view of the same building from the air.

## ABOUT THIS ARTICLE



Edwin and Allen Kramer.

This paper was presented before the IRE Professional Group on Broadcast Transmission Systems at the March 1953 IRE Convention. The building described in the article was designed by the firm of Kramer, Winner and Kramer, Architects and Broadcast Transmission Engineers (33 West 42nd Street, New York 36, N. Y.).

ALLEN and EDWIN KRAMER are practicing architects of national repute, whose experience includes the design of broadcast stations, theatres, medical, educational and industrial buildings. They have received numerous awards for architectural design, including the award of the American Academy in Rome.

LEWIS WINNER, the third member of the firm, has been active in communications and broadcasting since 1925. He was formerly editor of COMMUNICATIONS and TELEVISION ENGINEERING, is presently editorial director of Bryan Davis Publishing Company. He established his consulting practice in 1938, has just recently joined forces with the Kramers in order to provide a complete unified designing service for radio and television facilities.



Lewis Winner.

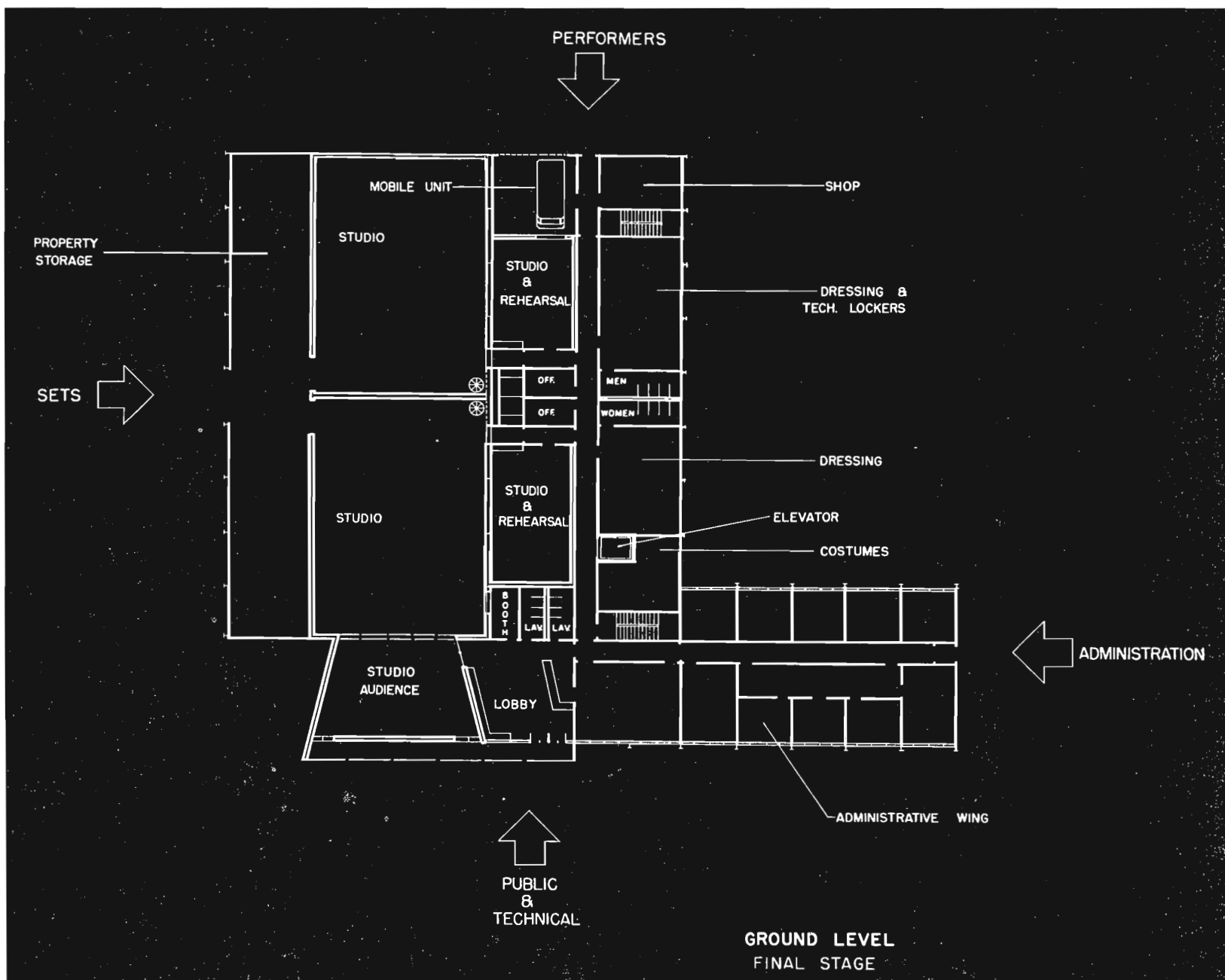

## DESCRIPTION OF THE BUILDING IN FINAL STAGE

A ground level plan for this final stage is illustrated in Fig. 3. The arrows show the points of entry of the various types of people who use the building. Control of this complicated traffic is essential and to a large extent this has determined the form of the building.

All facilities for the production of TV shows are located on one level and no other traffic is permitted to cross this area. Sets and heavy equipment are brought into the storage and workshop area from the left and eventually are moved onto the studio floor from that direction.

Performers enter the building from a rear parking lot. They go directly to the dressing rooms and feed into the studio area from the right. Costume storage is located with the dressing rooms. The layout also reveals that nowhere can performers and control room technicians interfere with each other. All the control rooms are located above.

Administrative and clerical personnel are restricted to the one-story wing on the far right, and the few who are authorized to enter the production or control sections can do so at the intersection of the wings.

The public and business callers are admitted to the lobby which provides access to the studio audience auditorium and to the general business offices. Control room personnel would enter through the lobby and go directly to the upper level by way of the stair at the hub of the plan.

In every stage of expansion the mobile units are housed in the rear of the building. They adjoin one of the TV studios and might conceivably be used to control a broadcast from the studio.

The upper level of the fully-expanded scheme is shown in Fig. 4. This second level occurs only over the central core of the building. Two TV control rooms with announcers' booths have direct visual con-

trol over the large studios. Immediately adjoining is the TV master control and shop. Directly across the hall is the film bloc. It consists of a fireproof film storage room, preview room, processing and editing group and the actual film projection room. Control for the multiplexers occurs in the master control room.

Control of the two smaller TV studios is handled blind. It is becoming increasingly obvious that direct visual control of a program is unnecessary except in the case of quite complex assignments. At a station visited recently, we found a very large studio with an adjacent control room located on the same floor level and equipped with a large window over the control consoles. The control personnel had long since found that from their position it was usually impossible to see large areas of the studio because of intervening sets and equipment. They had further found that these obstructions did not handicap them and had even-

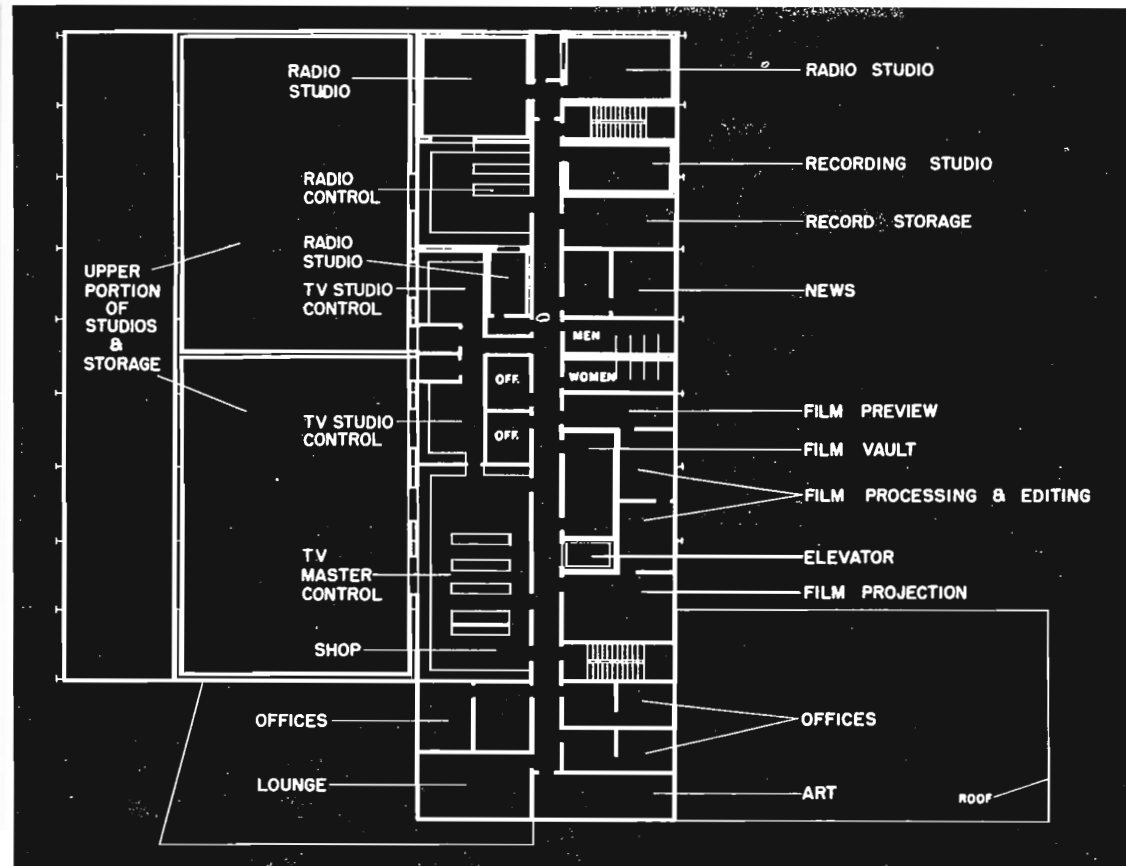

FIG. 4. Upper level plan of fully-expanded scheme.

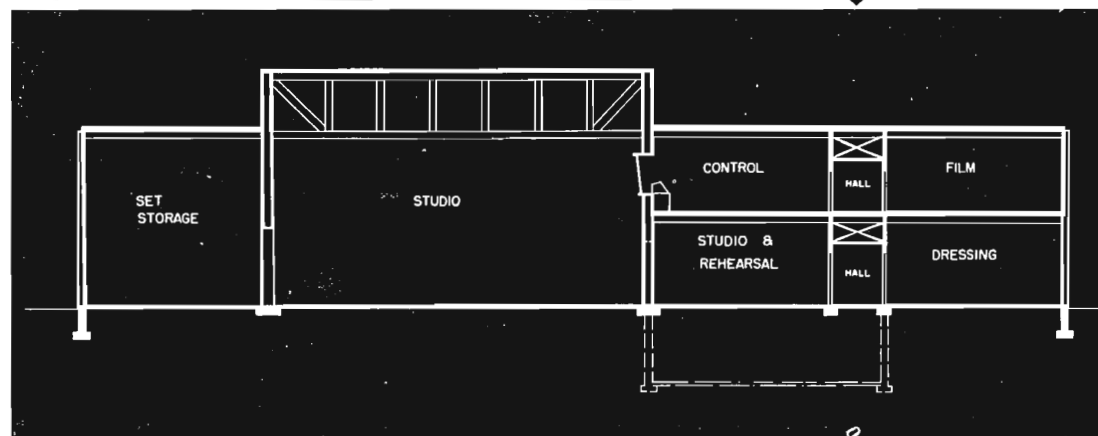

FIG. 5. Cross-sectional drawing which shows vertical relationships among various sections of building.

FIG. 3. Ground level plan for final stage of building.

tually permitted a permanent set to be erected directly in front of the window. Control windows are shown only in the largest studios and in each case, well above the top of the highest sets.

At one end of the TV control area are located the art room, offices for programming personnel, engineers, and a lounge for off-duty hours.

The far end of the upper level is devoted to radio broadcasting facilities. The master control room overlooks one of the large TV studios for those occasions when a program is broadcast by both TV and radio sections. This studio is also available for certain radio broadcasts such as a large choral group or an orchestra. In addition, there are three other broadcast studios including one small one for interviews and news broadcasts. Radio performers would enter the building at the performers' entrance in the rear and arrive at the studio doors via the stair without having passed through the building.

Across the hall from the control room is the recording studio which immediately adjoins the record library. The news room which will dispense material to both radio and TV is located directly between those departments.

The cross-section drawing, Fig. 5, shows graphically the vertical relationships among the various sections of the building. All production traffic is on one level and the control rooms overlook the large studios and operate undisturbed on a separate floor.

One of the advantages inherent in this plan is that the distinct separation of functions into wings and levels permits the building to be shut down except for a few essential rooms during the night hours. At the same time, the elements are brought together in such a manner that the areas requiring most wiring and those which produce the greatest heat load are concentrated for minimum cable length and economical duct work. Since the building is elaborately zoned, only those areas which

call for heating, cooling, or ventilation, are supplied with such facilities. Heat drawn from lights and equipment is used in cold weather and exhausted in summer.

While mechanical air conditioning will be a necessity in most climates, it is possible to reduce materially the cooling load on this building by the employment of a few simple devices. Accordingly, this building features large overhangs over glass areas, heat absorbent glass, light-colored wall surfaces, and a roof covered with brilliantly reflective white marble chips. This last device alone is capable of reducing roof temperatures by 30 degrees. Additional cooling can be obtained by the use of water spray nozzles on the roof. The water used is that which is recirculated by the air conditioners. Shade producing planting aids in the reduction of the outside noise levels as well as in cooling.

Let us now trace the stages of growth by which the building may evolve. Depending

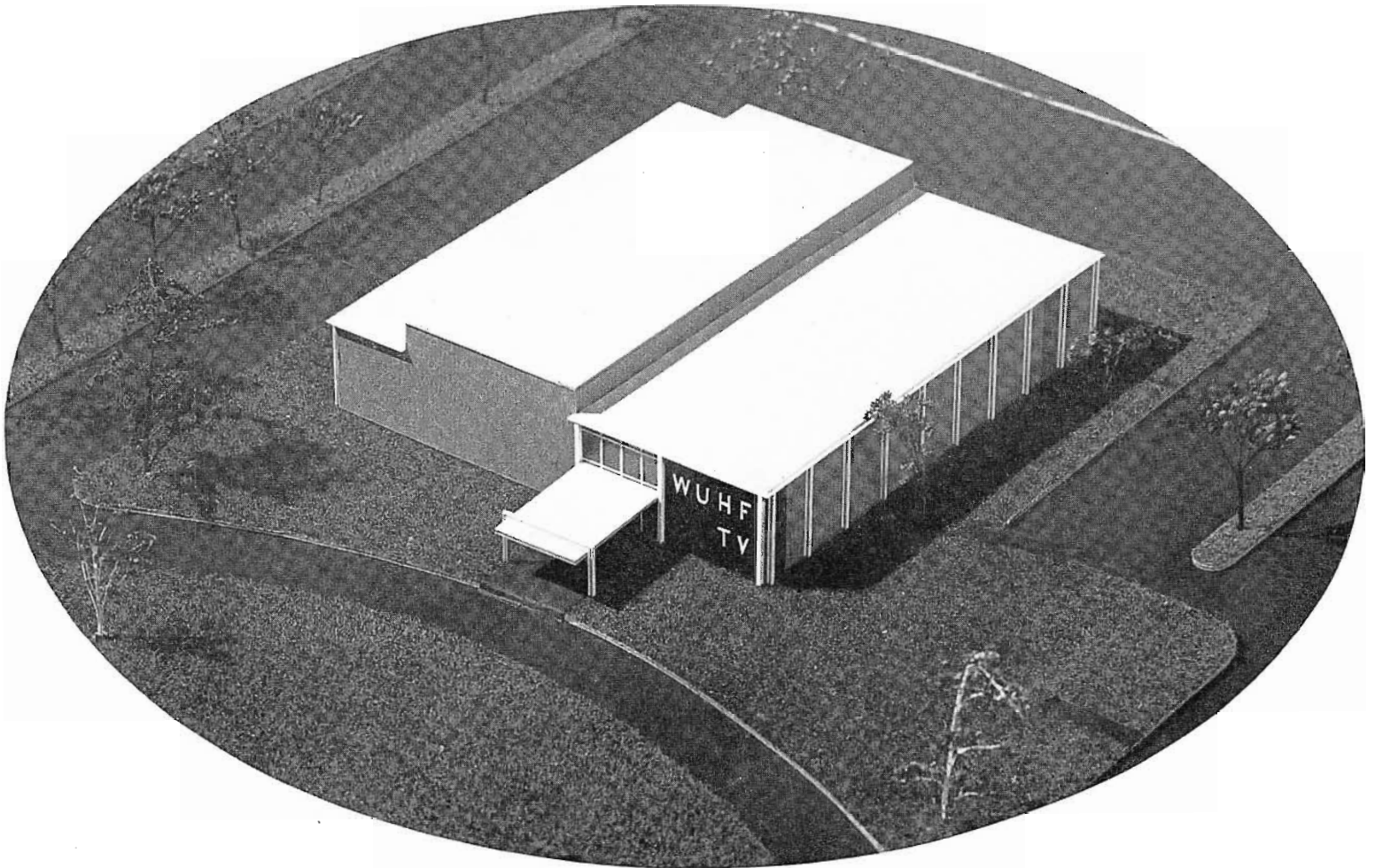

FIG. 6. View of radio-TV building without administrative wing.

## STEP-BY-STEP DEVELOPMENT OF THE BUILDING

upon the local demand, the studio audience may or may not be included, and the plant operates perfectly without it. At a slightly earlier stage, the building could exist without the administrative wing. This is shown in Fig. 6. During another period, only the two large studios would exist without the set storage area; one large studio would be active and the other would serve as storage area for all other studios. The administrative area is also capable of being expanded or reduced or even eliminated. It can, therefore, be seen that there are very many possible combinations during the period of growth. Given a plan which is properly begun, it is not even necessary to foretell the future with complete accuracy, either in regard to the type of facilities which may be needed or the sequence in which the need may arise.

This brings us to the first stage of construction, which is shown in Fig. 7. As far as function is concerned, it has been

assumed that we are dealing with a station that operates almost exclusively on network, film, and remote broadcasts. It would attempt only simple live broadcasts. An inspection of the plan shown in Fig. 8 indicates that the principles of traffic separation are already in operation. Performers enter from the rear parking area and use the dressing rooms and TV studio or go directly up to the radio studios. The large room opposite the TV studio which becomes a dressing room in a later stage, is here shown in use as the prop storage area. Mobile units are housed adjacent to the TV studio. The upper level, shown in Fig. 9, can be recognized as the core of the expanded stage described previously. The film bloc is almost identical. The TV control room is more modest in size but already positioned where it can overlook the large studio which is to come. Art work and programming offices are in the same relative position they will hold later, but reduced in size.

The radio facilities hold the closest resemblance to the final scheme, the only difference being that here there is a large studio in place of the small news broadcast studio seen previously. It will be noted that the radio control room gains the use of the very large TV studio when this change is made. The studio which separates the radio and TV control rooms could conceivably be used for simultaneous broadcasts of the simple type such as panel discussions, a lecture or a political speech.

Radio engineers are accustomed to precision, but in the main precision is not a characteristic of the building industry. Compared with almost any other modern enterprise, building is archaic. Buildings are usually one of a kind and they are painstakingly erected out of large numbers of small but heavy units such as brick and plaster which are bonded together so inseparably that they cannot be moved without being destroyed. Since most building

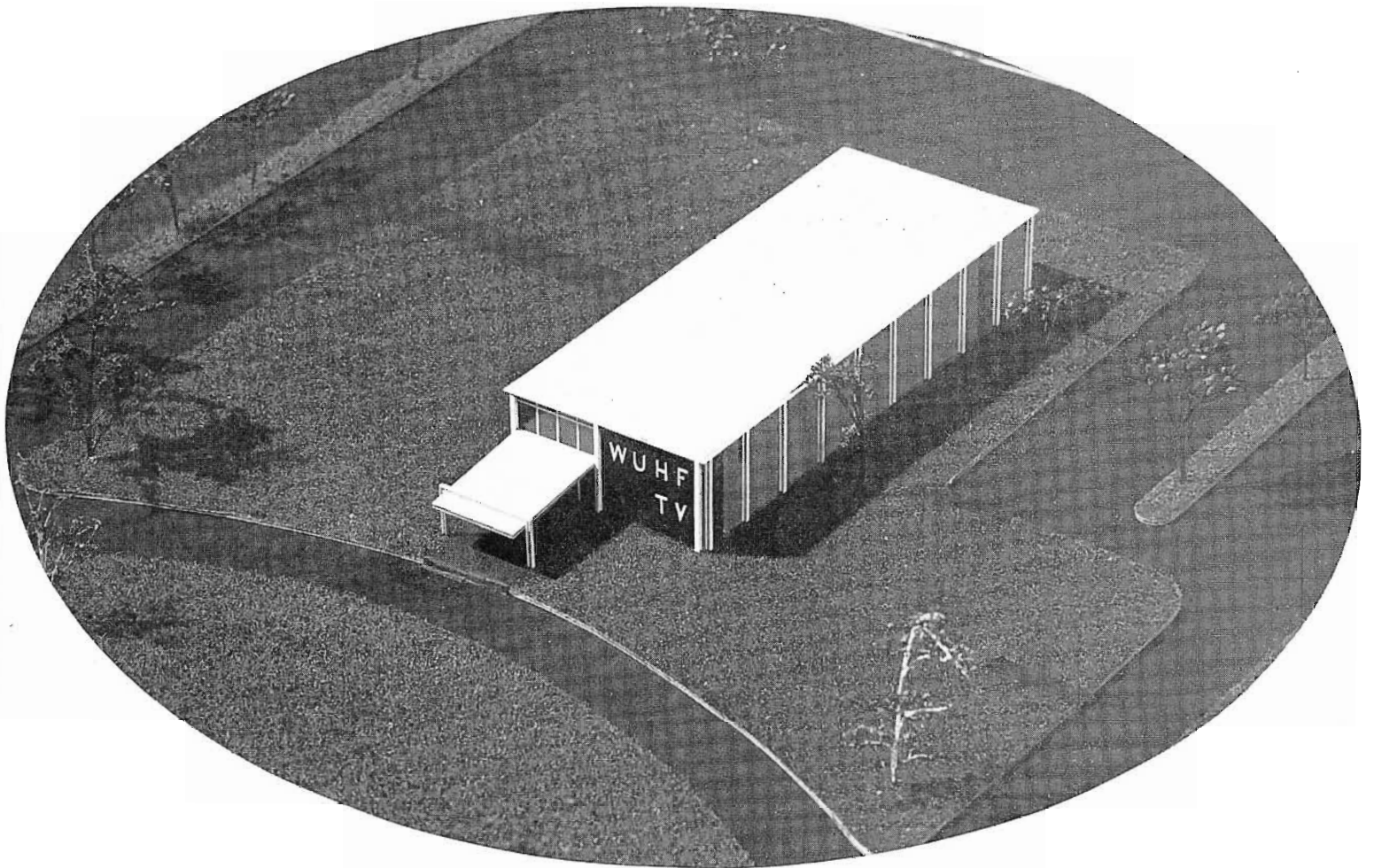

FIG. 7. Building in first stage of construction.

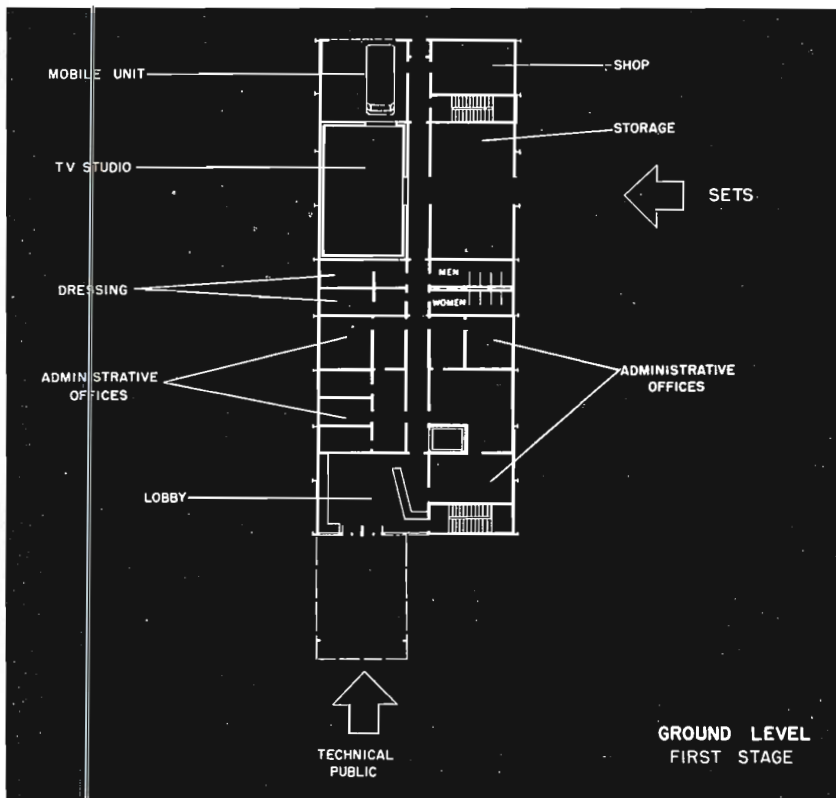

FIG. 8. Plan for ground level, in the first stage.

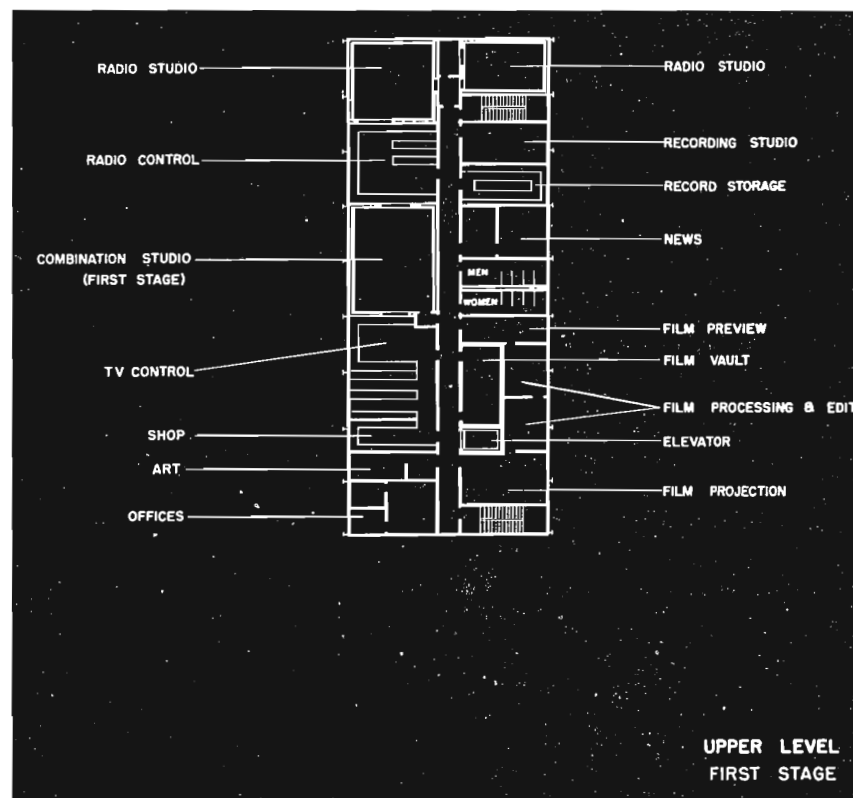
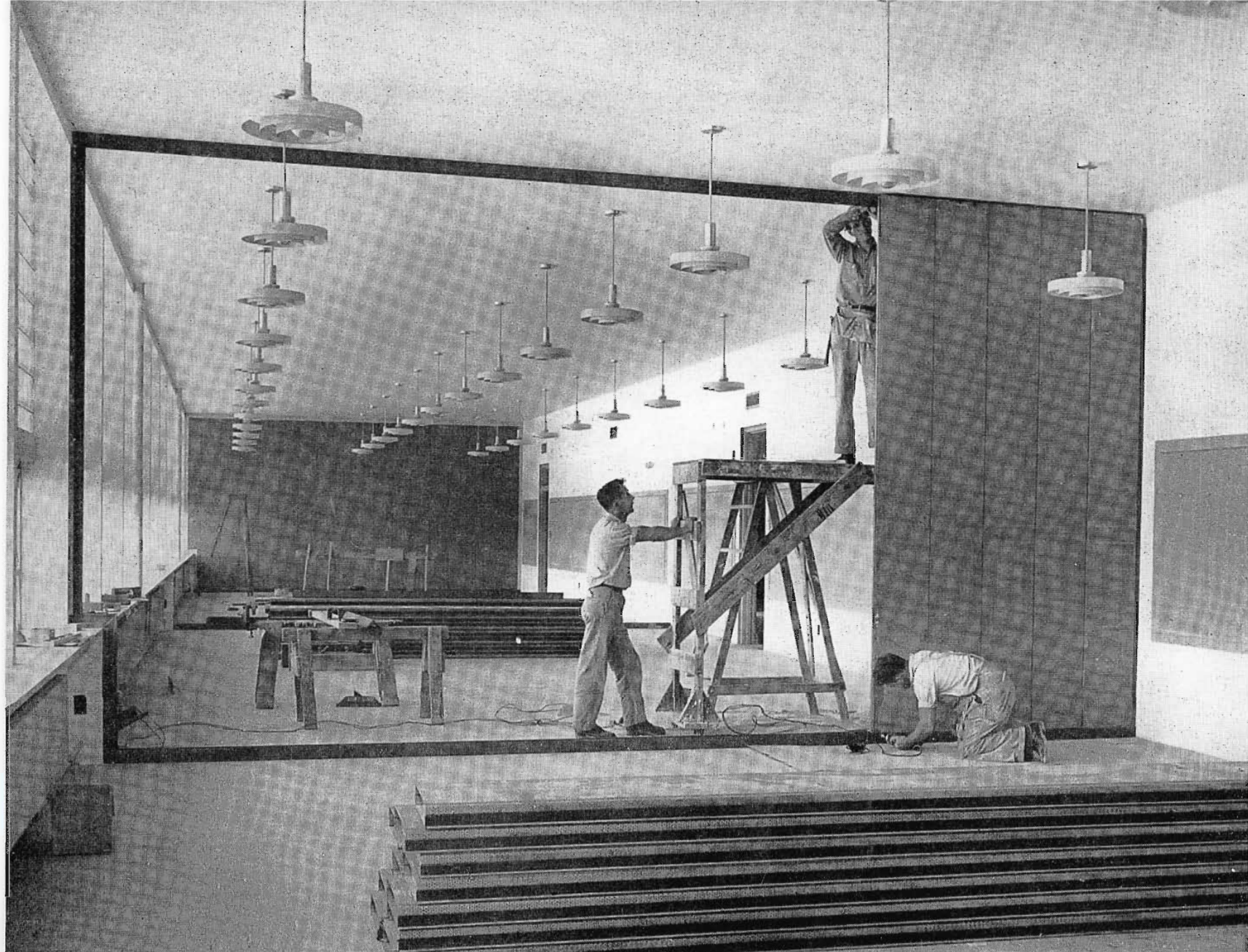

FIG. 9. Upper level plan, during first stage.



(Courtesy of Detroit Steel Products Co.)

FIG. 10. Erecting removable steel panel as an interior partition.

## CONSTRUCTING FOR FLEXIBILITY AND EXPANSION

materials are at least in part fabricated on the site, the general construction area becomes, for a very long time, a noisy and uninhabitable place. There is always a serious disadvantage, but it is particularly difficult when an alteration or addition to an existing building is involved. In the case of a TV station, attempting to maintain scheduled broadcasts, the complete disruption of facilities would be intolerable.

Expansion and flexibility are weasel words unless they are accompanied by a construction method as advanced as the building's planning.

If we were to try to designate the characteristics of an ideal construction material and method, we would ask for: (1) Strength; (2) lightness; (3) moderate first

cost; (4) economy of future maintenance; (5) attractive appearance; (6) speed, silence, and cleanliness during first installation and later rearrangement; (7) good sound absorption characteristics; (8) good sound insulation characteristics; (9) possibility of carrying wiring and cables within the thickness of walls and floors; (10) 100% salvage when walls are to be removed; (11) compliance with most building codes; and (12) availability in stock form anywhere in the country.

A material which satisfies almost all the requirements we have mentioned already exists. It is a building panel manufactured of steel or aluminum by about a dozen companies, and has been in use for several years, mainly in industrial applications. Its real capabilities have never been exploited

and its use seems to us to be particularly appropriate in radio and TV broadcasting buildings.

The use of one of the several panel types now available, is illustrated in Figs. 10 to 13.

Fig. 10 illustrates the ease of erection of the panels, here being employed as an interior partition.

A cut-away section of a wall panel is shown in Fig. 11. Here the type shown has been perforated on one side and filled with three inches of fiberglas. As such, it makes an extremely efficient sound absorber which protects permanently the soft absorbent material. This is far superior to fiberglas contained by wire netting which is often used. Any degree of sound absorbency can

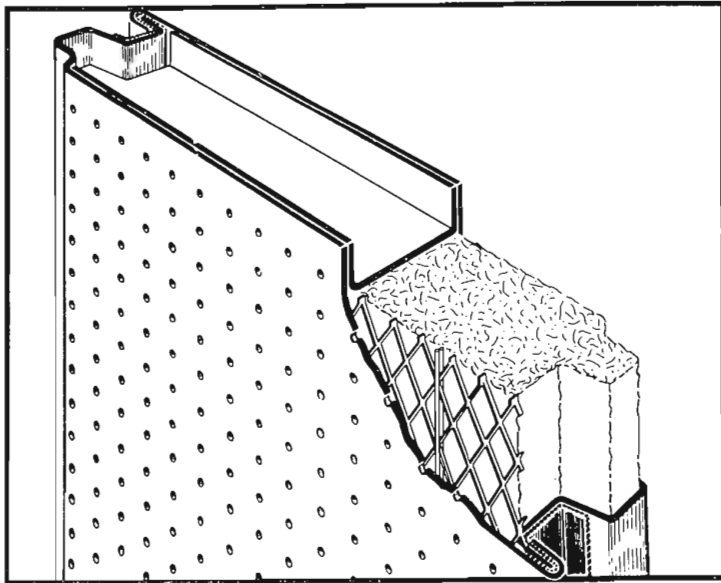

(Courtesy of Detroit Steel Products Co.)

FIG. 11. Cut-away section of perforated panel filled with fiberglas for sound absorption.

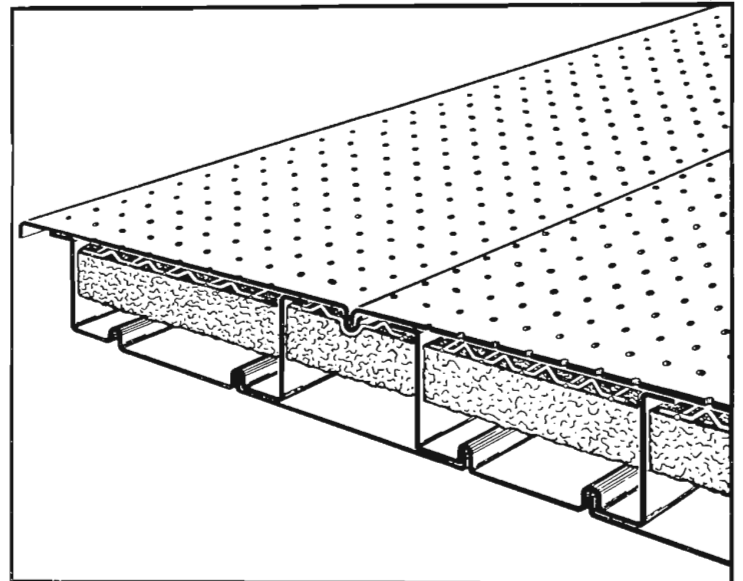

(Courtesy of Detroit Steel Products Co.)

FIG. 12. Ceiling and floor panels which may be perforated or not as requirements dictate.

be achieved in a room built of these panels, ie., a wall which required 50% treatment would be composed of perforated panels alternating with solid faced ones. Where careful sound insulation of adjoining spaces is necessary, this can be accomplished by using two walls slightly separated and isolated both from each other and from the floors and ceilings.

Fig. 12 illustrates the ceiling and floor panels which may also be perforated or not as the occasion demands. Here we have one material brought to the site completely assembled and acting both as the structural floor and as the sound absorber. These panels are now in use in a large recreation building in Binghamton, N. Y. In this building, an auditorium is located directly over a bowling alley, and insulation is so effective that no disturbance reaches the auditorium.

The cellular floor acts as a conveyor of wiring and cable. A predetermined grid is established on the floor with knockouts at frequent intervals. It becomes possible to tap power, telephone, and intercom lines at any point on the floor. The system is unaffected by the rearrangement of walls.

In Fig. 13 we have an office using the perforated panels. These are painted steel. In areas in which aluminum would be appropriate, maintenance costs are reduced to zero.

Our attempt here has been to suggest to prospective builders of radio and TV broadcasting stations a means of employing the benefits of prefabrication and standardization which are difficult to find in the building industry today.

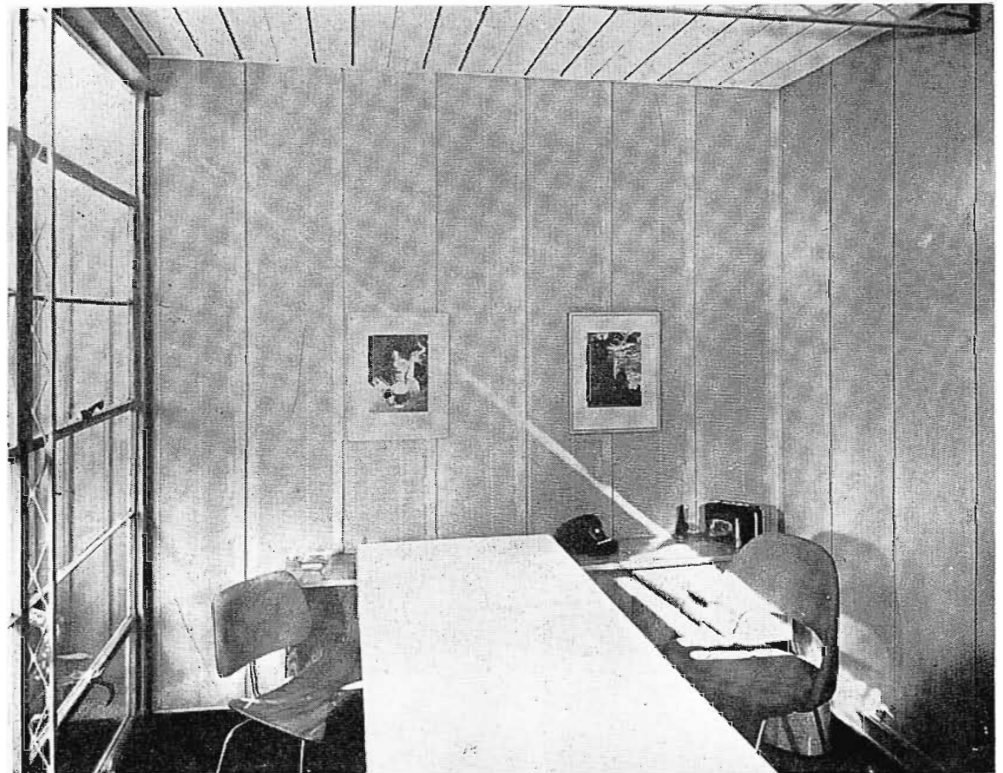

(Courtesy of Detroit Steel Products Co.)

FIG. 13. Office featuring use of perforated removable panels.

We have also tried to establish some principles for the functional arrangement of broadcasting stations. We have chosen as our means a theoretical example and it would be well to emphasize that no specific case could ever be solved in the same way. Irregularities of the site, relationships to other buildings, the necessity of building within an existing structure, use of existing electronic equipment, and the operating

characteristics of each organization will mold each building into a different outward form.

The direct cooperation of station executives, production personnel, engineers, and the architect will be required to produce a plan capable of solving its present problems and of meeting all of the surprises that the growing industry will produce.

# THE TTU-1B 1-KW UHF TV TRANSMITTER

by **T. M. GLUYAS** and **E. H. POTTER**

Broadcast Engineering Products Dept.

RCA Victor Division

The new RCA, 1-KW UHF Transmitter (already installed and successfully operating in a number of TV Stations) incorporates the most recent technical advances. It uses new and fewer tubes, and is considerably smaller than the original pioneer UHF television transmitter. Its predecessor,

the TTU-1A, operated as an experimental station at Bridgeport, Connecticut<sup>1</sup> for nearly three years, and was later moved to Portland, Oregon<sup>2</sup> to become the nation's first commercial UHF television transmitter. The new UHF television transmitter (TTU-1B) has a visual power

rating of 1 KW and a corresponding aural power of 500 watts. The power ratings

<sup>1</sup> BROADCAST NEWS No. 57, Jan. and Feb. 1950, "First UHF Transmitter Shipped."

<sup>2</sup> BROADCAST NEWS No. 71, Sept. and Oct. 1952, "UHF in Portland—How is it Doing?" John P. Taylor.

FIG. 1. The TTU-1B is housed in three easy-access, space-saving sliding door cabinets.





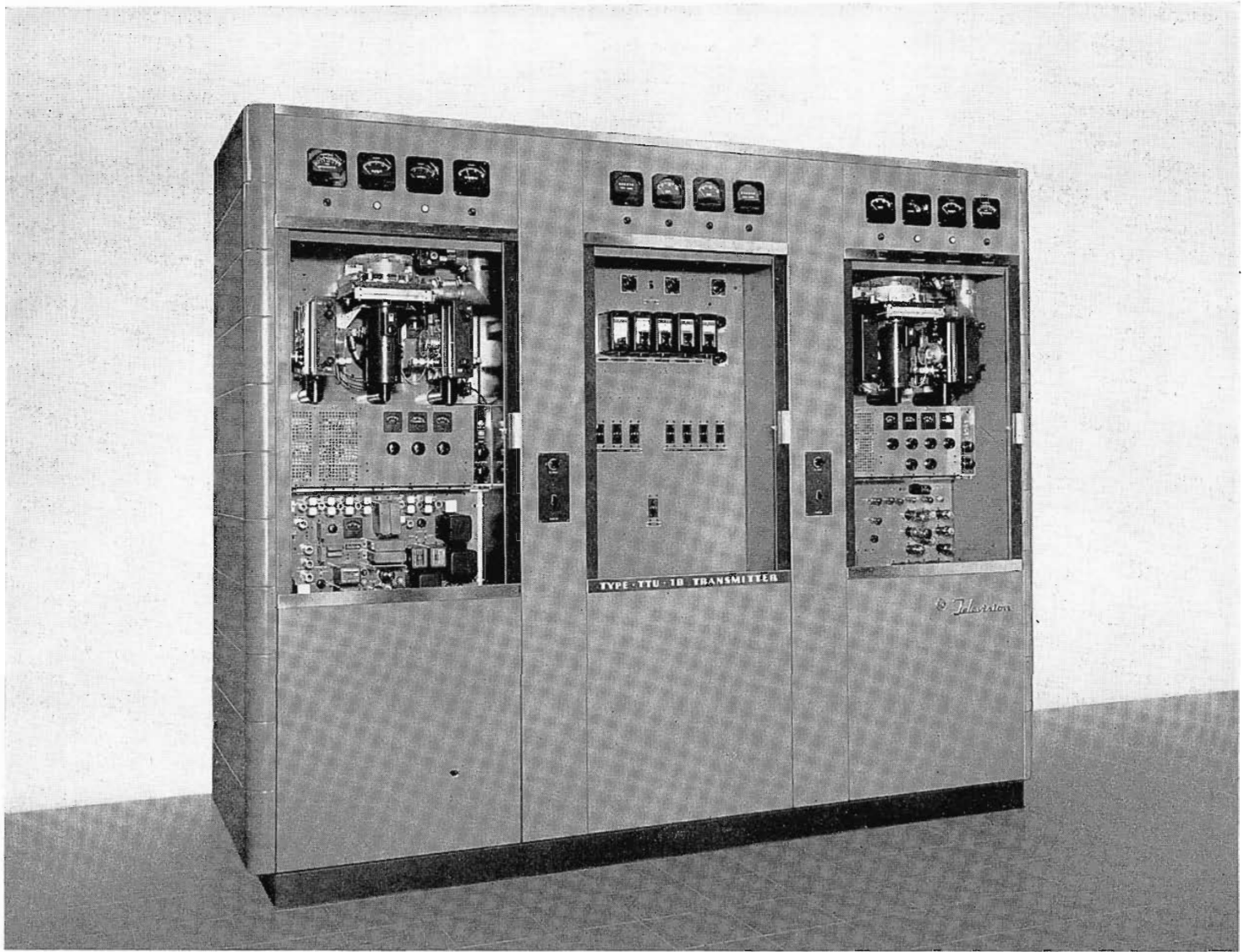

FIG. 2. The TTU-1B may be operated with sliding doors open or closed.

apply to the power at the output of the filterplexer.

#### General Description

This new transmitter is housed in three sliding door cabinets which conserve floor space and increase operating convenience. The center cabinet contains the necessary switches, relays, and circuit breakers for separate operation and overload protection of visual and aural transmitters, and a single blower which draws filtered air in through the rear lower section and supplies cooling air to the various tubes and units in the other two cabinets. It is the only rotating unit employed. The right hand cabinet contains the visual transmitter and the left hand cabinet contains the aural transmitter.

Except for the low level R-F stages and the video modulator, the aural and visual transmitters are practically identical. The frequency and power multiplier stages, IPA units, the final stages, and the high voltage plate supplies are the same in aural and visual portions of the transmitter. The aural and visual portions may be operated independently of each other except for the common cooling air supply. Some of the other mechanical features may be observed by inspection of the photographs. The sliding front doors are not interlocked and the transmitter may be operated with these doors open as shown in Fig. 2. Fig. 3 is a rear view of the visual transmitter with the door open. This photograph shows the clean, simple construction and the ready accessibility of

all components. Except for the necessary air ducts seen in this photograph, all components are mounted on the center vertical aluminum panel in order that they may be inspected, tested, and if necessary, easily repaired.

Fig. 4 shows a front view of the essential portions of the aural transmitter. The bottom third is occupied by the FM exciter which will be described in following paragraphs. The middle portion contains, behind an interlocked hinged panel, the middle level R-F stages ranging up to a power of 50 watts at a frequency of approximately 400 mcs. (half the final frequency). The three UHF cavities appear in the upper section of the photograph. These circuits are likewise described in greater detail in following paragraphs.

Fig. 5 is a block diagram of the visual transmitter.

### Radio Frequency Circuits

Since the aural and visual R-F circuits are identical except for the very low level stages most of the description of the visual circuit which follows will apply to the aural transmitter. Block diagrams of the visual and aural transmitters appear as Figs. 5 and 6.

The visual transmitter frequency is controlled by third overtone crystals to reduce the multiplication factor required to reach the high UHF channels and to insure the good stability necessary to meet requirements of "off-set" carrier operation which requires a final frequency stability of  $\pm 1000$  cycles.

Stability is also enhanced by accurate thermostatically controlled crystal heaters, low voltage regulated plate supply for the crystal oscillator, and a buffer stage.

The output of the visual crystal buffer stage is coupled to an RCA 6146 amplifier for channels 14 to 41 or tripler for channels 42 to 85. The 6146 is followed by two stages using RCA 4X150A tubes which triple or double respectively for the above mentioned channels. Including a 6161 doubler stage, to be described later, the frequency multiplication factor is 18 for the lower channels, and 24 for the higher channels.

The resonance output of the second 4X150A is one-half final frequency, and above the present VHF bands so the tuned circuits depart from conventional lumped constants. Thus the anode circuit consists of a pair of parallel plates with a movable shorting bar.

The doubler and IPA stages use RCA 6161 triode tubes, operated grounded grid, in special tuned circuits commonly called "cavities". The final amplifier is an air cooled tetrode—type 6181—in another special "cavity". To allow meter monitoring of power output, two reflectometers are coupled to the output transmission line, and read peak output power or standing wave ratios. An external filterplexer is used to combine the aural and visual signals

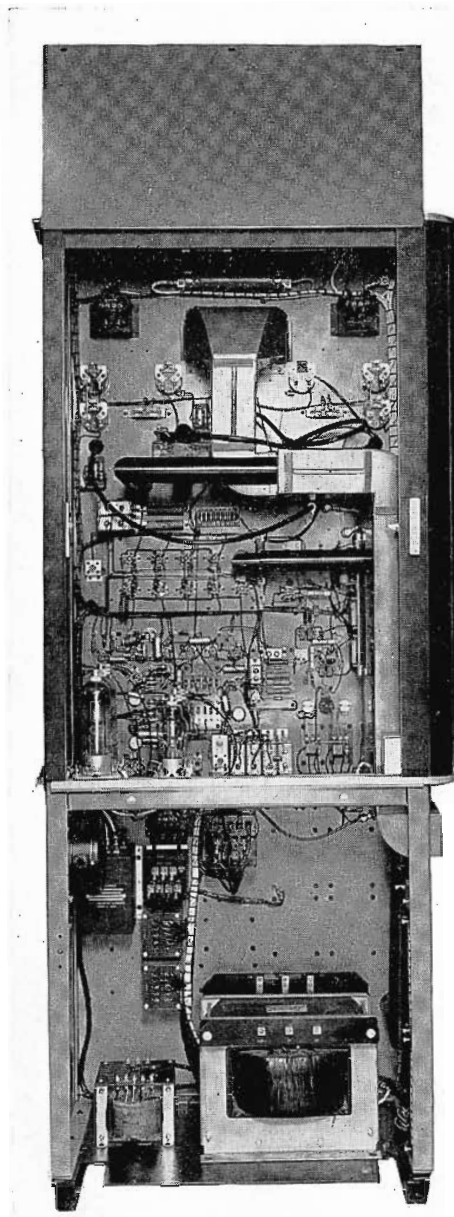

FIG. 3. Rear view of the visual transmitter shows the simplicity of construction and the ready accessibility of all components.

and to attenuate the undesired visual sideband as required by the FCC.

### Video Modulator

Video modulation is introduced into the cathode circuit of the power amplifier tube. A simplified schematic diagram of this portion of the circuit is shown in Fig. 7. The plate current of the PA flows through eight RCA 6146 tubes which are operated in parallel as the modulator. The modulator stage itself is preceded by three video amplifier stages which utilize negative feedback from the modulator to the second video stage. This improves the linearity of the modulator and maintains a flat amplitude vs. frequency response in the last two

video amplifier stages without the use of peaking coils.

In addition to the negative feedback loop; a second feedback path will be observed to the cathode of the first video amplifier. This is a positive feedback circuit whose frequency characteristic is opposite in amplitude and phase to the characteristics of the resistance-capacitance coupling elements between the first and second video amplifier stages. The positive feedback complements and corrects the amplitude vs. frequency characteristic of the first video amplifier stage. A variable capacitor in the positive feedback circuit furnishes a convenient adjustment for making the overall video response flat with frequency or it may be adjusted to give an overall rising frequency characteristic to compensate for the loss in high frequency response in the coupling network between the modulator and the modulated radio frequency amplifier.

The DC component of the television signal is restored at the grid of the modulator which is in turn direct coupled to the modulated power amplifier. The DC restoration circuit is a conventional clamp circuit.

The TTU-1B is used in conjunction with a TA-5C stabilizing amplifier. The picture and sync controls for the stabilizing amplifier are included in the transmitter console so that the depth of modulation and the synchronizing to picture ratio can be monitored and adjusted from the operating position. Since the transmitter is always preceded by the stabilizing amplifier which, among other things, adjusts the sync/picture ratio, no sync stretching is built into the transmitter proper. No white stretching is required because of the excellent linearity resulting from the use of negative feedback and explained in detail on a following page.

### FM Aural Exciter

A block diagram of the FM aural exciter is shown in Fig. 6. The FM aural exciter is direct crystal controlled, and has a frequency stability of 4000 cycles at final frequency. The crystal oscillator in the phase modulator operates at 130 KC, and the large multiplication required to reach

the final frequency would result in a large deviation not only at the desired modulating rate, but for noise components as well. To keep the noise level down, it is necessary to translate the carrier and its side-band components to a higher frequency without increasing the frequency deviation. This is done by a heterodyning process using a second crystal oscillator.

A low frequency crystal oscillator and a pulse shaper produce a series of narrow pulses which are used to synchronize a sawtooth generator. The sawtooth produced is very linear, but is clipped at a level corresponding to the instantaneous audio modulation applied. New pulses are formed from the clipped sawtooth but the new pulses vary in time at an audio rate. These pulses, still at the oscillator frequency, are fed to a series of frequency multipliers and are restored to sinewave form. The second crystal oscillator and mixer translates the frequency modulated signal to a new portion of the spectrum without altering the initial deviation. Amplifiers which follow the mixer increase the signal level and act as selective filters to prevent any other signal components from being passed to the remainder of the transmitter.

Since this unit is a phase modulator, a frequency selective device is provided at the audio input terminals to make the audio output of the second audio amplifier vary inversely with frequency. This is done to maintain a frequency deviation independent of the modulating frequency. A pre-emphasis network is included in the modulator.

#### **Cavities for the 6161 Tubes— Doubler and IPA**

Three cavities were shown in the upper portion of the photograph, Fig. 4. The right hand rectangular cavity is a doubler employing a 6161 tube which reaches the final frequency with a power output of approximately 90 watts. The left hand rectangular cavity is an IPA stage also employing a grounded grid 6161 triode. The power output of this stage is approximately 150 watts. Although one of these cavities is a doubler and the other an amplifier they are very similar in construction and will

be described simultaneously. Fig. 8 is a closer view of the rectangular cavity showing the top side or output circuit and the bottom side or input circuit. Fig. 9 is similar but with the top and bottom cover plates removed to show the internal construction.

The term "cavity" has grown in meaning to describe almost any kind of UHF circuit where the radio frequency currents flow on the inside of and are entirely contained by a metal box or structure of almost any shape. At lower frequencies it is possible to talk about lumped circuits, parallel lines, or coaxial lines.

At ultra high frequencies so much of the circuit is contained within the tube, and the external circuit is so short and complicated by mechanical requirements and R-F blocking capacitors, that it is no longer possible to distinguish between coaxial lines, radial transmission lines, or resonant spaces of irregular shape. All of these are lumped under the generic term "cavity". The resonant circuit formed by the 6161 tube and its cavity consists of the coaxial circuit within the tube plus the circuit formed by two parallel completely enclosed plates which make up the rectangular cavity circuit. As may be seen in

FIG. 4. R-f circuits of the aural transmitter.

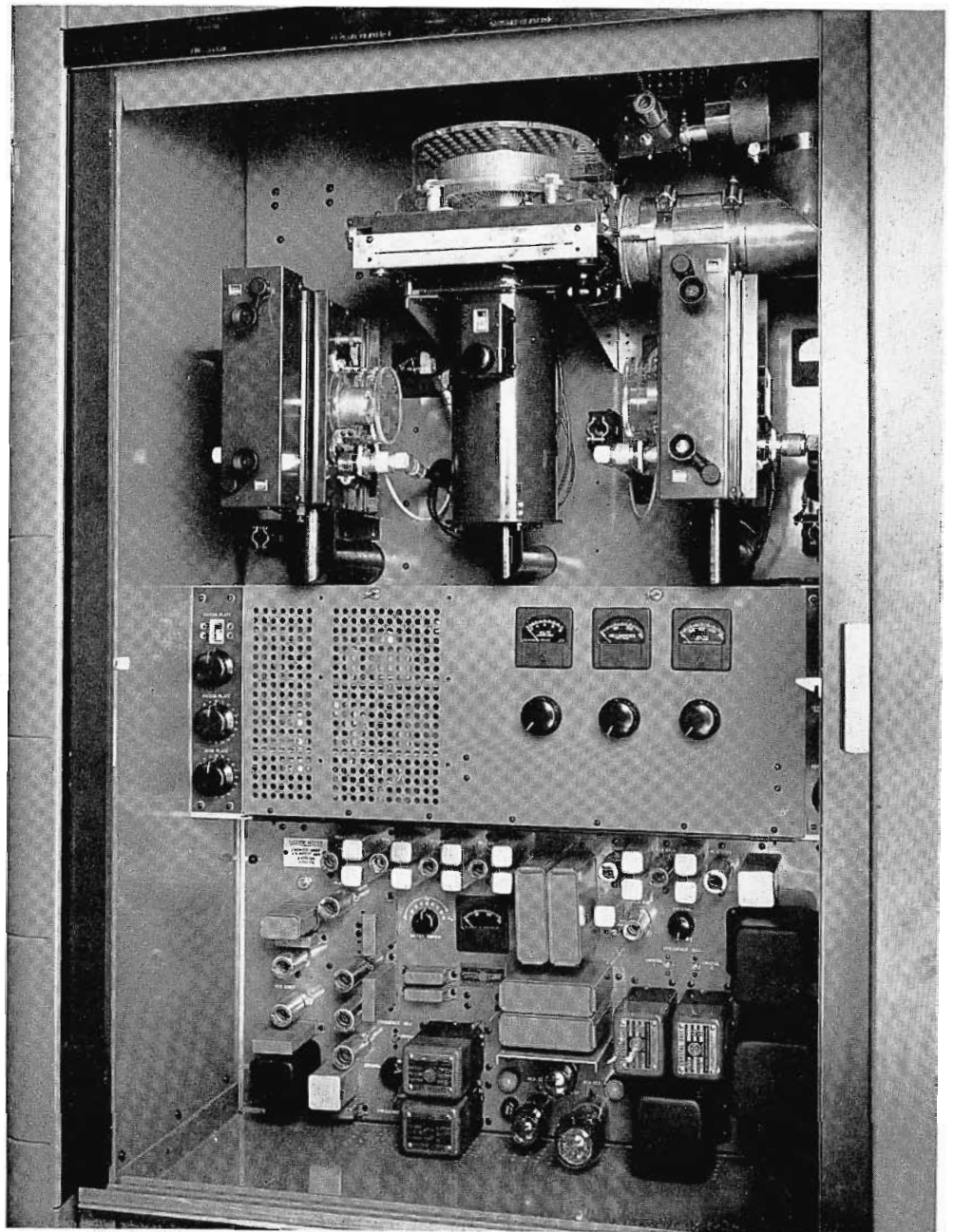

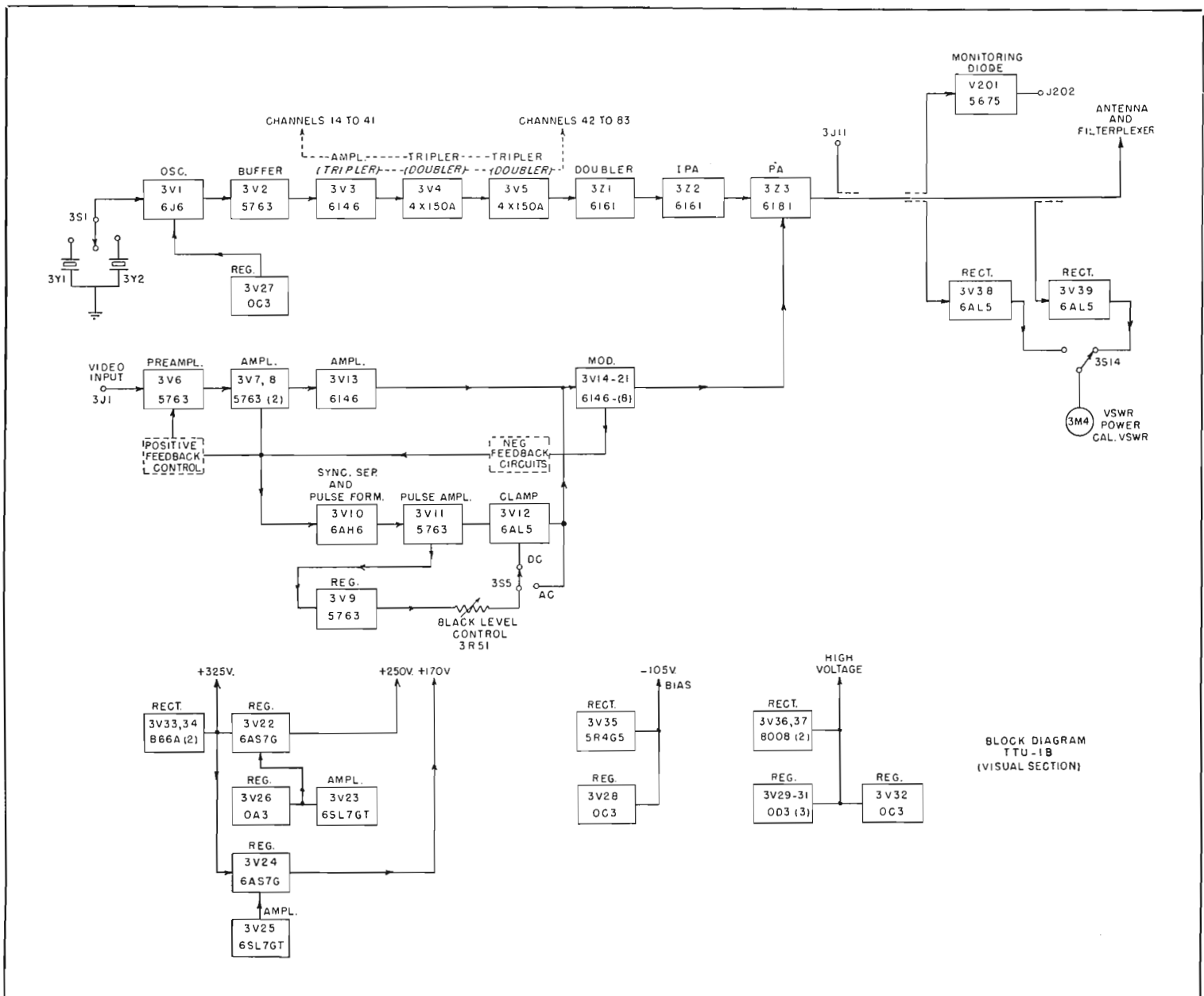

FIG. 5. Block diagram of TTU-1B visual transmitter.

Fig. 9 there is a central common plate which is connected through a blocking capacitor to the grid of the 6161. One side of this plate carries current for the output circuit and the other side of this plate carries the current flowing in the input circuit. It would perhaps be more descriptive of the mode of operation if the stage were called a *grid separation circuit* rather than a *grounded grid circuit*.

Tuning or cavity resonance is accomplished by moving a pair—one on either side of the tube—of shorting bars in unison toward or away from the tube. Each shorting bar has some six hundred sliding contacts to insure a connection of low R-F

resistance between the parallel plates. These are formed by a silver clad coil spring which tips over to form numerous contacts of uniform pressure between the flat plates and the grooved shorting bars.

The cathode-grid and grid-anode sections are similar except for lumped capacity sections around the tube itself chosen to obtain the required tuning range with minimum circuit loss. The output circuit is operated in the  $\frac{1}{4}$  wave mode and the load is capacitively coupled to the output circuit by the disc shaped probe visible in the photograph. The input circuit is operated in the  $\frac{1}{4}$  wavelength mode when the cavity is arranged as a doubler, and in the

$\frac{1}{4}$  wave mode when the cavity is arranged as an amplifier. In the amplifier, advantage is taken of the phase reversal in the input circuit between the first and second quarter wavelength. This gives an out of phase voltage useful in neutralizing the stage.

A probe leading from the output to the input circuit through a small hole in the center plate picks up enough of the energy in the cavity to balance out and neutralize the energy coupled through the cathode to plate capacitance of the 6161 tube.

When the cavity is used as a doubler the capacity loading is arranged so that the input circuit, when it is tuned in the  $\frac{1}{4}$  wavelength mode at the input frequency,

will not simultaneously resonate at the final frequency. This arrangement makes the doubler stable and neutralization is not required. For convenience in metering and for safety the cavity is operated at ground potential. All of the electrodes; cathode, grid, and plate, are bypassed to the cavity with a series of silvered mica capacitors shown scattered around in the photograph, Fig. 9.

Flexible coaxial cables are used to couple the ultra high frequency energy from the output of one cavity to the input circuit of the following cavity. It is highly desirable although not absolutely necessary to match the impedance of the cable at its termination. This prevents excessive circulating current in the cable which would cause overheating and excessive tuning drift. Impedance matching is accomplished by adjusting the coupling and the tuning of the input circuit until the cable is properly terminated. A plug-in reflectometer is furnished for measuring the standing wave ratio in the interconnecting cable. Type RG8U cable is used to interconnect the cavities with the exception of the cable between the IPA and PA. The cable used here is RG87A/U which is similar to RG8U except that Teflon insulation is used to avoid any possibility of the cable short circuiting due to overheating as a result of an impedance mismatch and excessive circulating current. Cable fittings are type HN, similar to type N except they are a high voltage variety, to eliminate the danger of flash over if the cavities are misadjusted.

### PA Cavity

A composite photograph (Fig. 10) shows a top and bottom view of the PA cavity. Fig. 11 is a photograph of a disassembled cavity and Fig. 12 is a photograph of a 6181 tube. The 6181 tetrode employed in the final amplifier is operated grounded grid grounded screen. The screen grid is bypassed to the output circuit; the control grid is bypassed to the input circuit. In addition, the two grids are bypassed to each other.

The output circuit operates in the  $\frac{1}{4}$  wavelength mode and a broadly tuned loop

couple energy from the output circuit to the  $\frac{3}{8}$ -inch 50 ohm coaxial output transmission line. The output coupling is adjusted by rotating the loop. The tuning of the output circuit is achieved by simultaneously moving four shorting bars which are apparent in Fig. 11 as segments of a circle. These segments are driven from the tuning knob by a chain drive and racks and pinions. When the circuit is adjusted for the highest possible frequency the four segments move together to form a circle around the tube except for a small opening which is occupied by the output coupling loop. Thus at the upper end of the band, the circuit is contained almost entirely within the tube.

The input circuit is an open ended coaxial transmission line. It has an electrical length of  $\frac{1}{2}$  wavelength for the lower channels and one wavelength for the upper channels. The circuit capacitance is small compared to the tube capacitance so it is possible to introduce modulation into the cathode circuit while maintaining a low capacity to ground for the video signal. A tuned  $\frac{1}{4}$  wave choke is used to connect the cathode and filament of the 6181 to a low capacity filament transformer and to the modulator.

Cooling air is circulated through all of the cavities. In the case of the 6161 doubler and 6161 IPA the air is brought into the cavity and then out through the radia-

FIG. 6. Block diagram of TTU-1B aural transmitter.

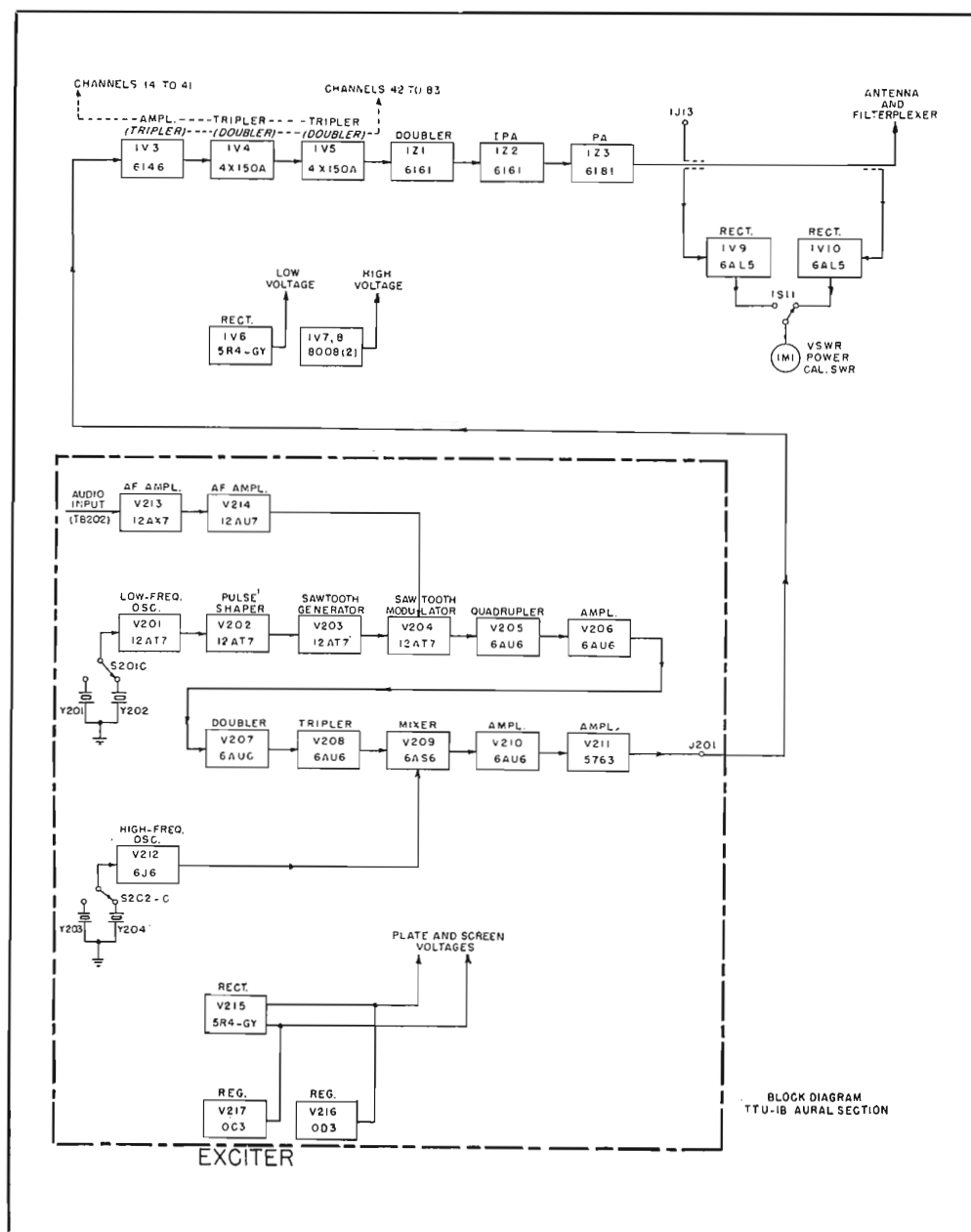

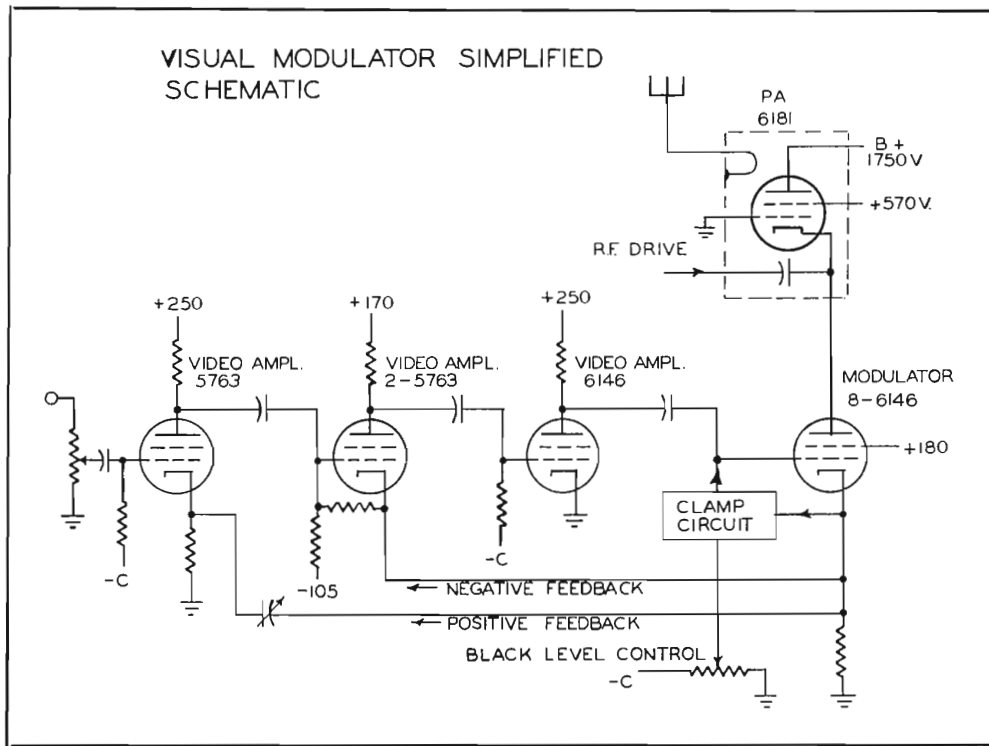

FIG. 7. Visual modulator simplified schematic.

tor of the tube. In the PA, three separate sources of air are provided. Air is supplied via a Teflon tube up the center of the input cavity to blast the filament seal. Another source of air leads in through the rear of the cavity between the control grid and the screen grid sections to cool the remaining tube seals and the output cavity. Finally the main source of air enters a

plastic shield on top of the cavity and exhausts through the 6181 radiator out of the top of an interlocked cover.

#### Features and Performance Information

One of the design objectives was to make the linearity superior to any previously designed television transmitter; yet some early experience indicated that it would be

more difficult to obtain good linearity at UHF than at VHF.

The non-linearity problem was tackled boldly by negative feedback. Since the PA and modulator are connected in series, the modulator plate current and the power amplifier plate current are identical. Consequently, the negative current feedback from the modulator to the video amplifier insures that the plate current of the PA will be a linear function of the instantaneous video signal. By virtue of this negative feedback not only the PA plate current, but the overall transmitter performance was made linear. The results are shown in Fig. 13. Fig. 13A shows the entire modulation characteristic. The curve, Fig. 13B, is restricted in amplitude to the excursion produced by the picture information; that is, the curve reports the entire range from black to white. To draw a comparison with AM broadcast operation the total harmonic distortion was measured for the conditions as shown in Fig. 13B. The distortion was 2½% for Fig. 13A, and 1% for Fig. 13B. This is the first television transmitter ever produced with distortion comparable to an AM broadcast transmitter.

#### Frequency Response

Maintaining a good flat frequency response in broadband R-F circuits at UHF is not easy. To obtain reasonably flat response in over-coupled circuits, individual tuned circuits can hardly be allowed to wander off tune by as much as 1 mc. Yet the slightest change in the electrical contact to the tube or in the tuning element may produce such a frequency shift. Ordinary heating due to R-F currents or to heat flow to the circuit from the vacuum tube can also produce appreciable frequency change. In the TTU-1B it was possible to avoid all over-coupled circuits, and the associated problem of keeping them in tune. Modulation is applied to the final tube so that the output tank is the principal UHF circuit determining the transmitter frequency response. Since the 6181 tube works at relatively low voltage and high current it must be heavily loaded. This produces a very wide bandwidth in the single tuned output circuit. When the load is adjusted for maximum power output, the bandwidth automatically comes out to be about 15 mc. The power amplifier operates full double sideband and the frequency response is not radically affected by circuit adjustment.

FIG. 8. Rectangular cavity for 6161 grounded grid doubler or amplifier.

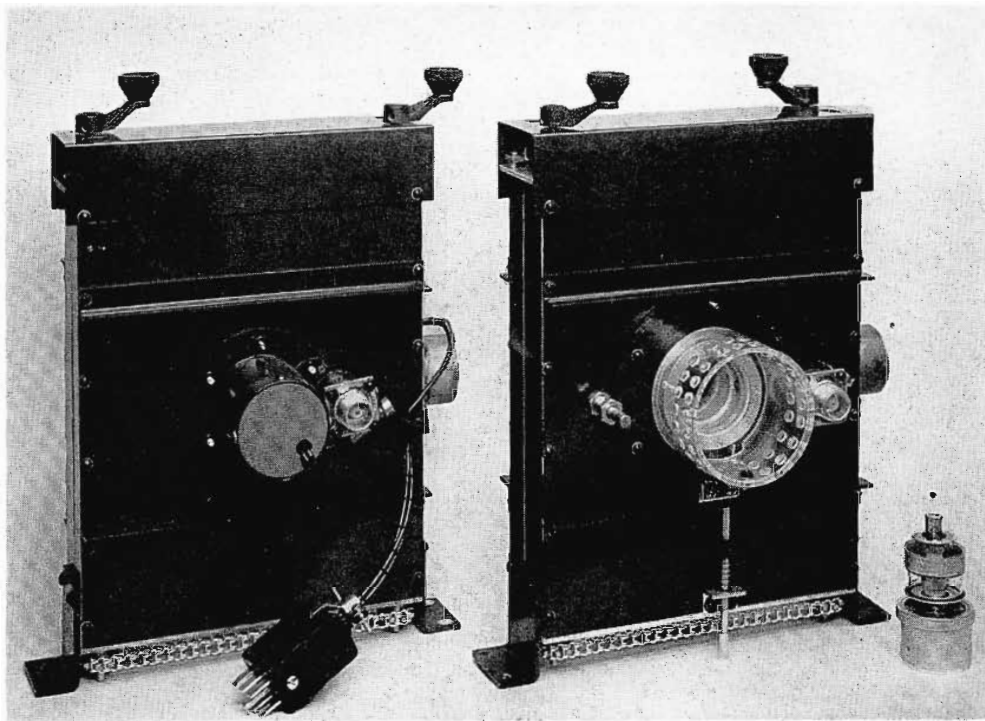

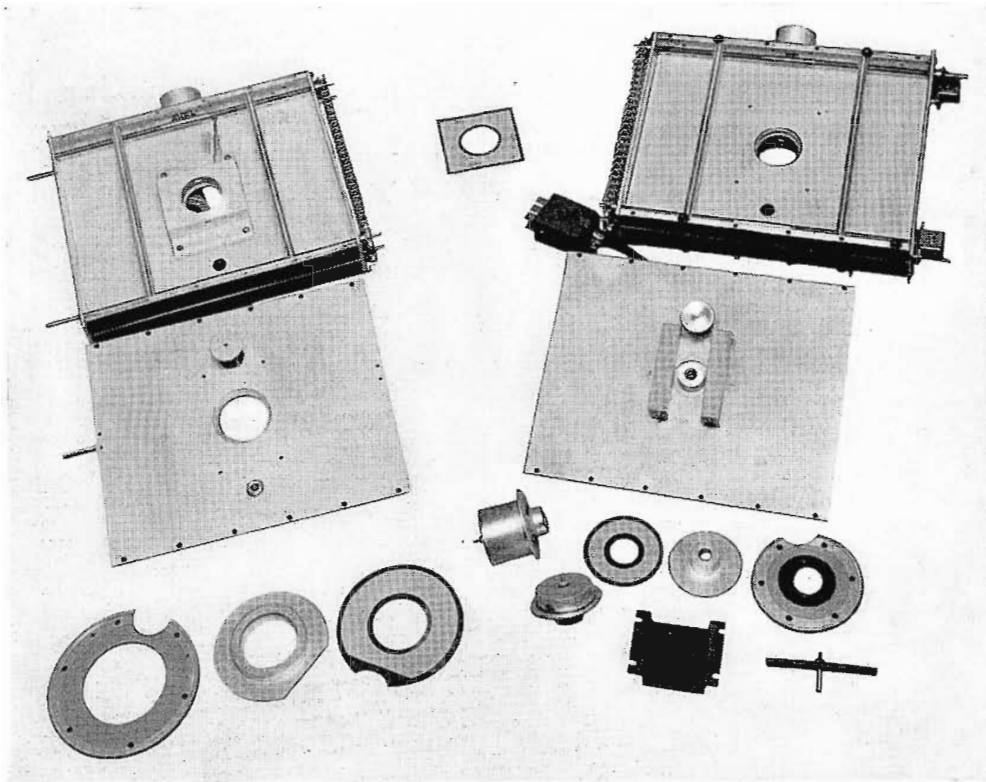

FIG. 9. Rectangular cavity for 6161 disassembled.

The modulator frequency response is adjusted by a single trimmer condenser in the feedback circuit to obtain a slightly rising frequency response which compensates for the frequency characteristic of the tuned circuit in the output of the mod-

ulated R-F amplifier. The overall response is flat and the bandwidth is determined principally by the modulator cutoff. Fig. 14 shows the overall response of the transmitter. The marker is set to 4.5 mc. The frequency response in this figure is taken

ahead of the filterplexer and, of course, the response at the output of the filterplexer must contain a deep notch at 4.5 mc. similar to that produced by the sound traps in a television receiver. The frequency response shown in Fig. 14 is the output of a diode demodulator ahead of the filterplexer. The apparatus arrangement is shown in the block diagram of Fig. 15. Photograph of a picture on a kinescope fed by the same diode demodulator is shown in Fig. 16.

#### Problems Associated with Grounded Grid Operation

In order not to leave a false impression by over-simplifying the problem of high quality picture transmission, an interesting dilemma of UHF transmitter design will be discussed. At any television broadcast frequency it is extremely difficult to prevent feedback around the modulated amplifier to the degree required for high quality picture transmission. The slightest lack of neutralization is cause for the R-F drive, which should be steady, to be modulated by the video signal. At UHF the problem is much worse due to the lower reactance of the feedback capacitance at the ultra high carrier frequency. If grounded cathode operation is attempted, the problem of adequate neutralization is considerable. By operating grounded grid,

FIG. 10. Photo "A" (left) shows completely assembled PA cavity. Photo "B" (right) shows bottom view, partially disassembled.

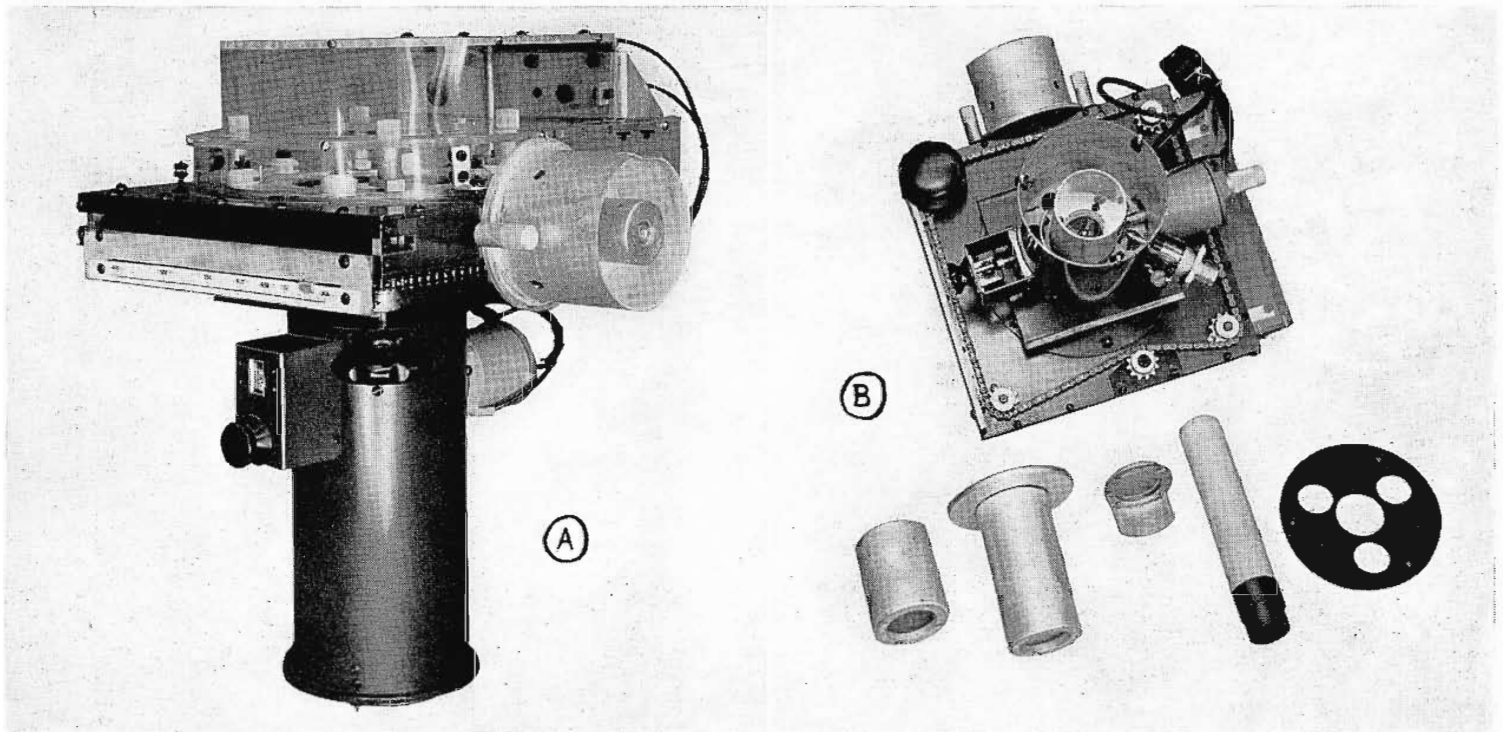

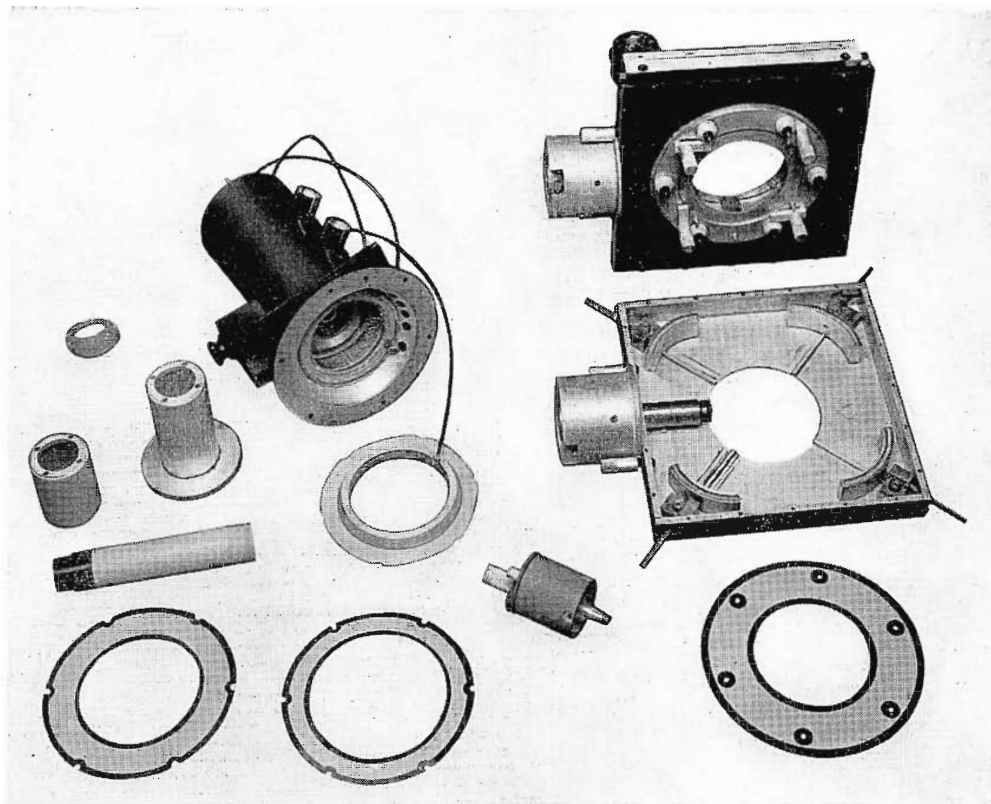

FIG. 11. PA cavity completely disassembled.



FIG. 12. 618 tube used in both aural and visual outputs.

grounded screen, two electrostatic shields are interposed between the input and output circuits so the problem of electrostatic feedback is negligible; however, the plate current then flows in both the input and output circuits and there is strong conductive coupling. At UHF some of this same difficulty occurs even in grounded cathode operation. If complete neutralization were possible in the grounded cathode stage, there would still be considerable

modulation of the R-F driving signal by the video signal because the input circuit of the modulated stage is loaded due to transit time effects and this load is proportional to plate current.

In the TTU-1B transmitter, grounded grid, grounded screen operation was chosen so the problem of neutralization is avoided but there is appreciable incidental load impedance modulation of the R-F driver.

Since it is difficult to maintain a flat frequency response in the R-F circuits between the driver and the power amplifier, this incidental modulation results in some picture degradation. This defect is minimized in two ways. The cable between the IPA and the PA is chosen to be a multiple of  $\frac{1}{2}$  wavelength so that the IPA and the PA act like a simple overcoupled circuit with amplitude but not phase modulation. More important than this is the subtle effect of the "cure-all" negative feedback employed in the modulator. This feedback makes the plate current of the power amplifier directly proportional to the video signal regardless of any perturbing influence such as the incidental modulation of

FIG. 13A (left) and FIG. 13B (right). Curves showing linearity of TTU-1B.

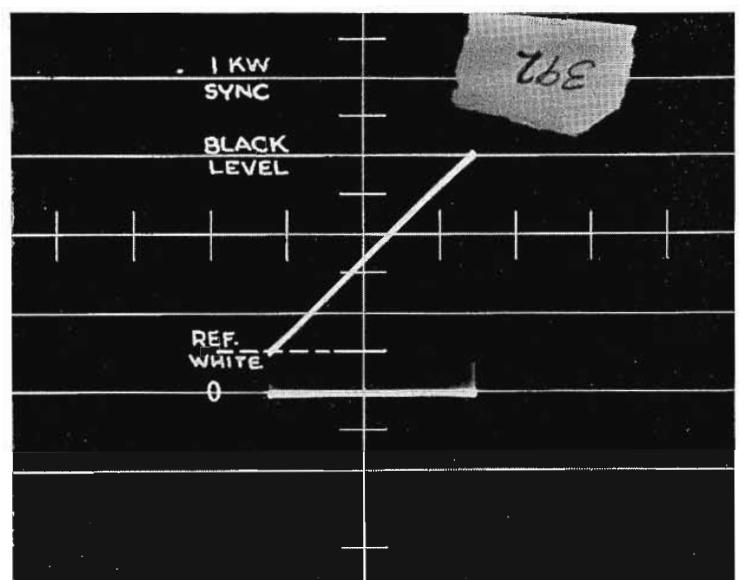
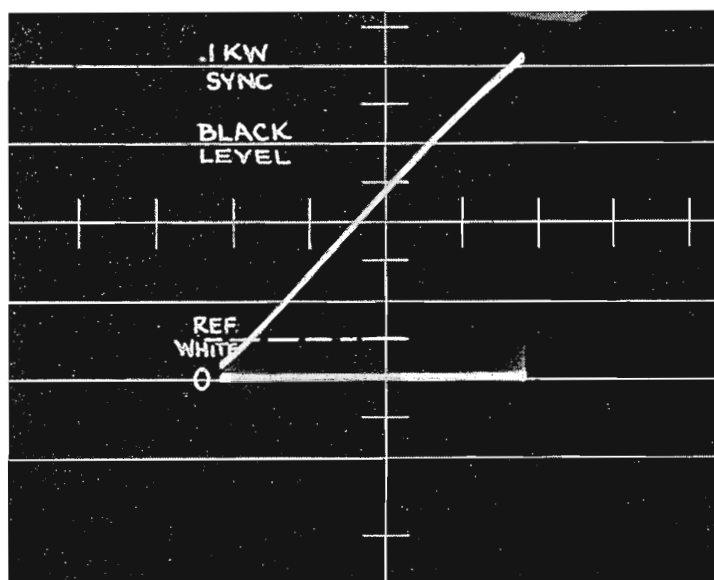



the R-F driver. Since the changing R-F excitation cannot influence the power amplifier plate current it simply shifts the bias of the PA producing a change in plate current flow angle which results in a small second order disturbance in the picture. Stated as simply as possible the effect is that the constant current modulator absorbs the distortion that would otherwise be produced by the incidental modulation of the driver. The curious result is that the picture distortion seen in the demodulator on the output transmission line or on the air is very, very slight, but the distortion is considerably more noticeable on the monitor takeoff point from the modulator. Thus, if one wishes to see the picture quality of which the modulator is capable, it is necessary to remove the R-F excitation by turning off the crystal and putting a positive bias on the power amplifier to restore the modulator plate current to the normal value.

### Summary of Performance

In spite of the new and difficult problems that were encountered in the design of this ultra high frequency transmitter, important improvements in picture quality were made over the earlier VHF transmitters which have been doing such a good job of broadcasting since about 1946. The linearity of the transmitter which controls the ability to reproduce the delicate shading in the highlights and shadows has been markedly improved. The frequency response of this new transmitter is slightly better than in the earlier VHF transmitters. More important than this, the good frequency response is obtained during transmitter tuneup almost automatically by virtue of circuit simplification and negative feedback. Thus, picture reproductions

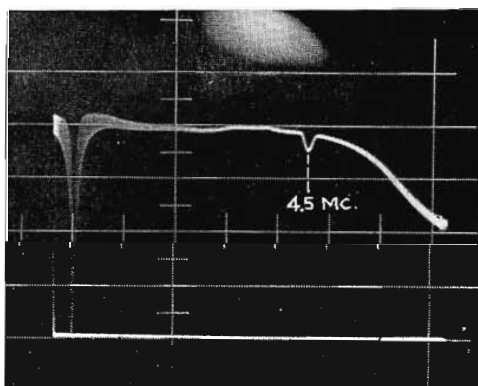

FIG. 14. Overall frequency response of the TTU-1B—Marker at 4.5 mc.

### BLOCK DIAGRAM OF APPARATUS USED IN MAKING PERFORMANCE MEASUREMENTS

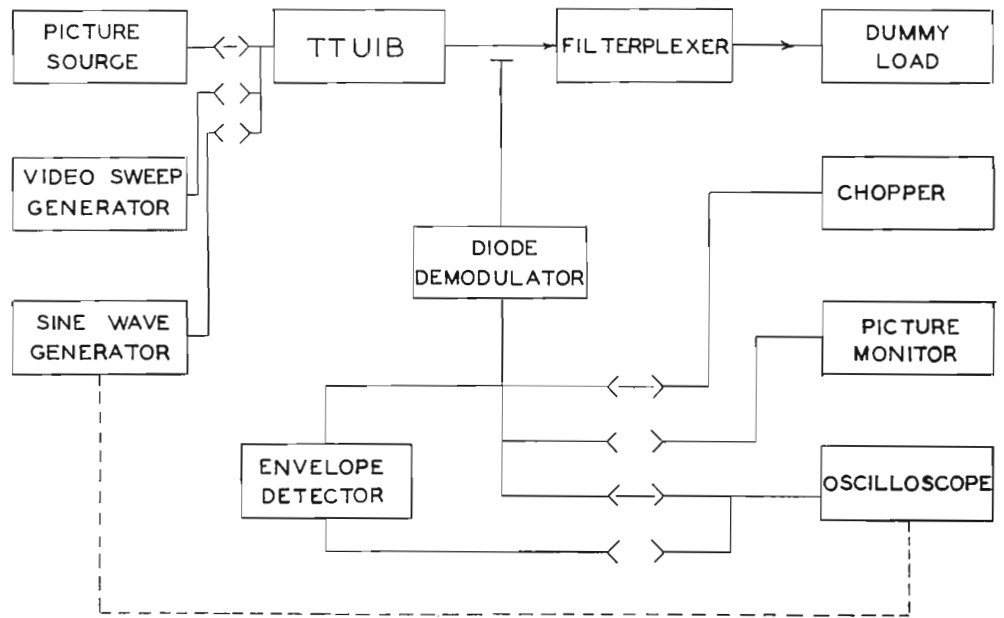

FIG. 15. Block diagram of apparatus arrangement used in making performance measurements.

from the TTU-1B transmitter are of consistently high quality.

### Acknowledgments

The design of the TTU-1B occupied a considerable number of engineers for about one year. At various stages of the develop-

ment and design the following engineers were part of the engineering team: E. G. McCall, T. P. Tissot, B. Wise, J. A. Aurand, L. S. Lappin, and the authors, and it would be possible to point out many individual developments and inventions contributed by these men.

FIG. 16. Kine photo of TTU-1B output.

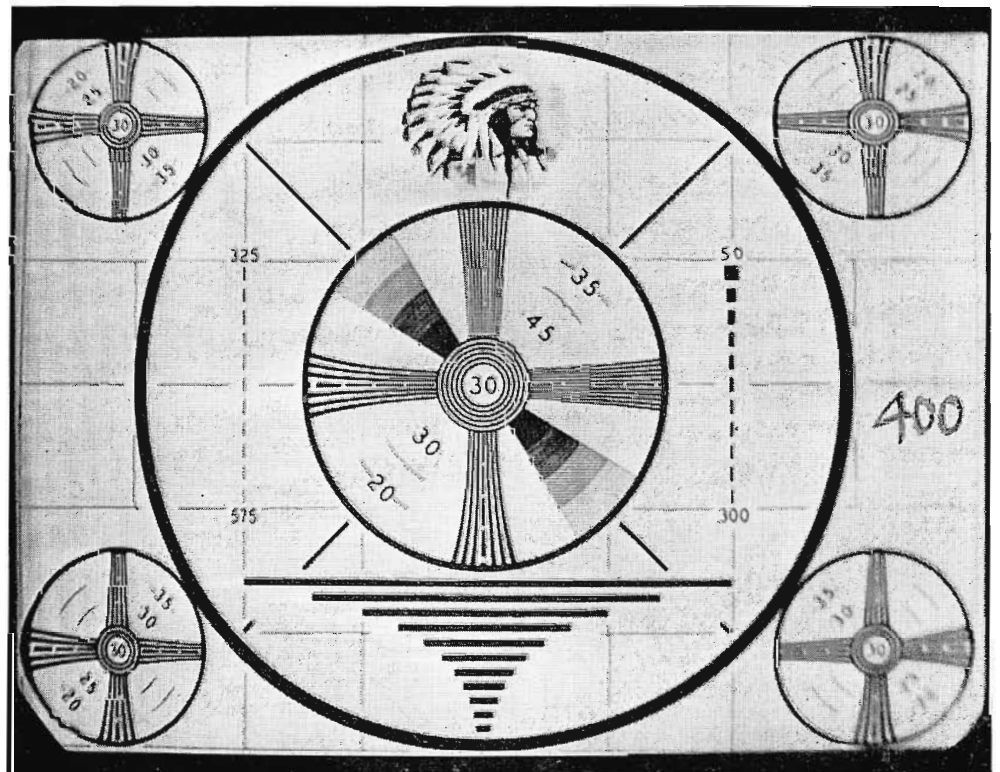



FIG. 1. KDYL-TV's transmitter is perched on the very top of an 8500-foot mountain ridge. Nearly 4 miles of the winding all-weather road which the station constructed to provide year-round accessibility is visible in this aerial view.



John M. Baldwin, Vice President Engineering, Intermountain Broadcasting and Television Corporation. He planned and supervised construction of KDYL-TV's mountaintop transmitter installation.

## BUILDING A TV

**KDYL-TV, LOCATED ON 8500 FOOT HIGH MOUNTAIN, PROVIDES COVERAGE OF 27,500 SQUARE MILE AREA**

**by J. M. BALDWIN**  
 Vice President Engineering  
 Intermountain Broadcasting and  
 Television Corporation

On November 22, Station KDYL-TV, a pioneer television broadcaster of the Far West since 1947, transferred controls to its new mountain top transmitter, seventeen miles southwest of Salt Lake City, and at that moment enlarged its Class B coverage from 1950 to 27,500 square miles, and

increased its potential audience to include 85 percent of the population of Utah, as well as portions of Idaho, Wyoming and Nevada.

This act culminated a long period of planning from the early pioneer days of 1947 when the station first took the air with a composite 400 watt transmitter and single bay antenna, with later increases to 1000 watts and a three bay antenna, giving a 3-KW ERP. This pioneer station was located on the highest building available

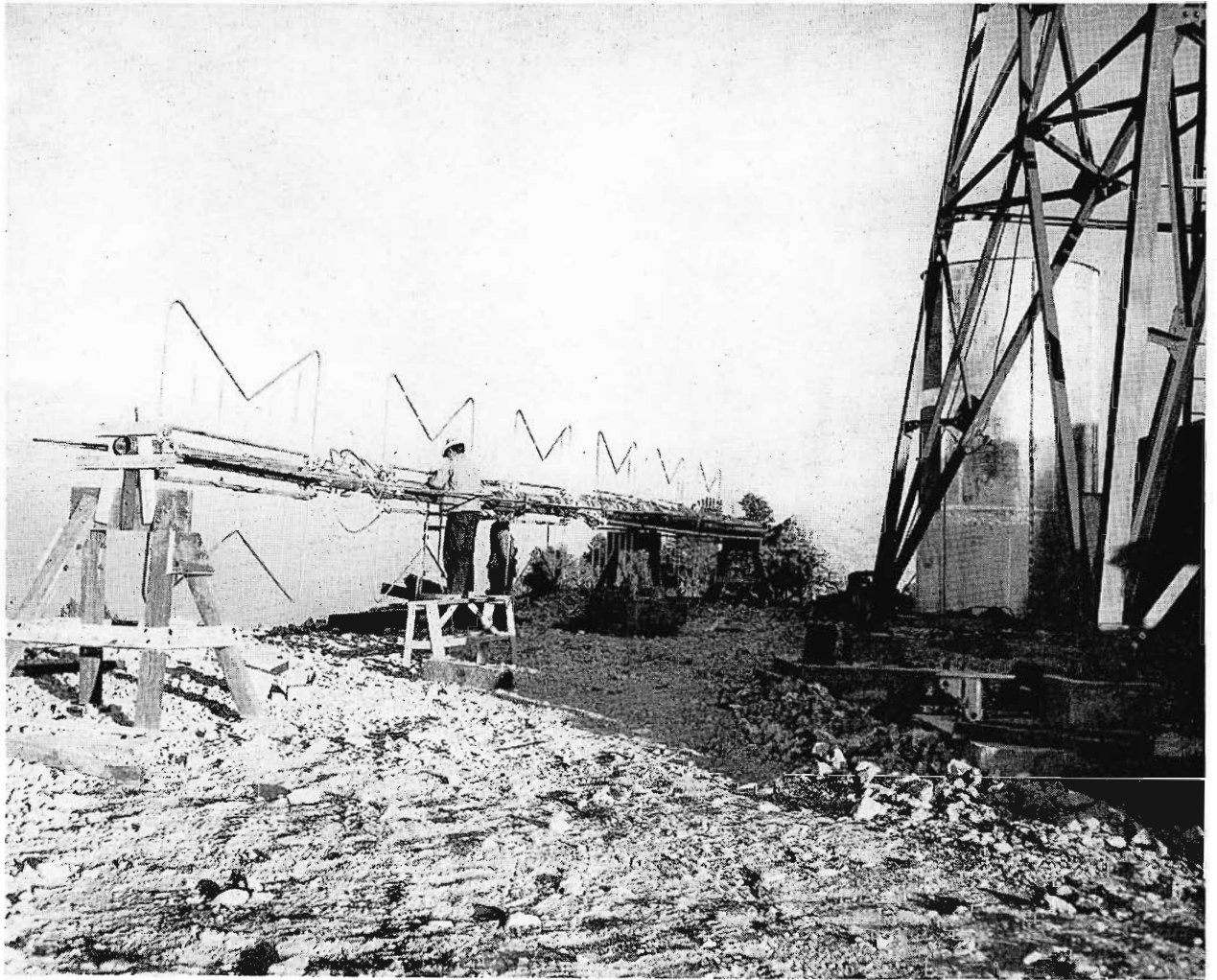

FIG. 2. Assembling the RCA six-bay turnstile at the KDYL-TV site. The base of the specially-built extra-heavy 100-foot tower on which the antenna is mounted is at the right. The microwave receiving antennas are enclosed in the silo-like structure behind the tower. Everything used at this very exposed site had to be of very heavy construction. The fact that the standard RCA turnstile antenna stands up under such extreme conditions is an indication of its high reliability.

## STATION ON A MOUNTAIN TOP

in downtown Salt Lake City, and due to the encircling mountains, was unable to reach out very far. Large concentrations of population north and south of the city were unable to receive satisfactory service, and it was early realized that the station would eventually be compelled to move to a mountain site in order to bring television to them.

### SELECTING A SITE

The first step in selecting a site was to find a general location in the mountains where it would be possible to secure line of sight conditions to the general area requir-

ing service. This limited potential locations to the Oquirrh Mountains, about sixteen miles west of Salt Lake City. The location finally selected, after consideration of the factors of accessibility, (power and roads), the approximate costs of development and the signal requirements of Salt Lake City, is on an 8500-foot spur of the Oquirrh Mountains, since christened Mt. Vision. Although it is not the highest available site, factors of accessibility dictated its choice. The aerial photographs made by the Department of Agriculture were invaluable in its selection, as it was possible through the use of a stereoscope, to see perspective on these photos and obtain the

same effect as though actually looking at the mountains from a point many miles above. These aerial photographs enabled us to plot several alternate routes for a road to the summit of the mountain, with more detailed planning on a topographic map made by the U. S. G. S. from these aerial photos. As a result of the time spent in these preliminary studies, it was possible to plan a permanent road, with a predetermined grade, before actually setting foot on the mountain. In addition, several flights were made over the area during the severe winter of 1951-52 and photographs taken in order to determine the areas of greatest snow concentration, so that these



FIG. 3. Before construction could start it was necessary to bull-doze a flat place on the ridge. This is a view looking north from the building site. Southern Idaho is visible in the distance. KDYL-TV covers 87% of Utah, as well as parts of Idaho, Wyoming and Nevada.

areas could be avoided in plotting the road location. The choice of a grade to use was a little more difficult, as snow and ice would be a limiting factor, and if the grades were too steep, difficulty might be had in climbing during the winter months, and on the other hand, the use of too low a grade would lengthen the road and increase its cost proportionally. After considerable pro and conning, a value of 10 percent (ten feet rise in each hundred) was selected and it has proven to be a fortunate choice. Ordinary passenger cars can negotiate this grade in second gear without undue heating, and the four-wheel drive station wagons which are used by the station employees, go up in four-wheel drive high gear.

### CONSTRUCTION OF THE FOUNDATION

In order to start construction at the summit as soon as possible a temporary road was bulldozed out in three weeks. This road took off from an existing logging trail at the head of a canyon and had grades as high as 25 percent in places. All of the construction material and equipment was hauled over this road without mishap, and allowed construction of the station to proceed while the permanent road was being built.

After the summit was reached, the top of the mountain was blasted and bulldozed to a flat area 125 by 225 feet. Trenches

for the foundations of the building and pits for the foundation were blasted and reinforcing rods sunk into holes drilled in the rock, so that both structures would be firmly keyed into the mountain itself. This precaution was considered worthwhile as very high winds are prevalent during the winter, and the design of the building and tower foundations was based on the dead weight of the concrete alone being sufficient to hold the structures against a 115-mile-an-hour wind; consequently, the additional anchorage provided by keying into the rock is a bonus safety factor. One hundred and fifty yards of cement was used in the building and tower foundations, with a total weight of over 400,000 pounds.

FIG. 4 (right). Another view of the mountain top taken during pouring of the foundations. All the construction materials and equipment were, of necessity, hauled over a temporary road having grades as high as 25% in places.

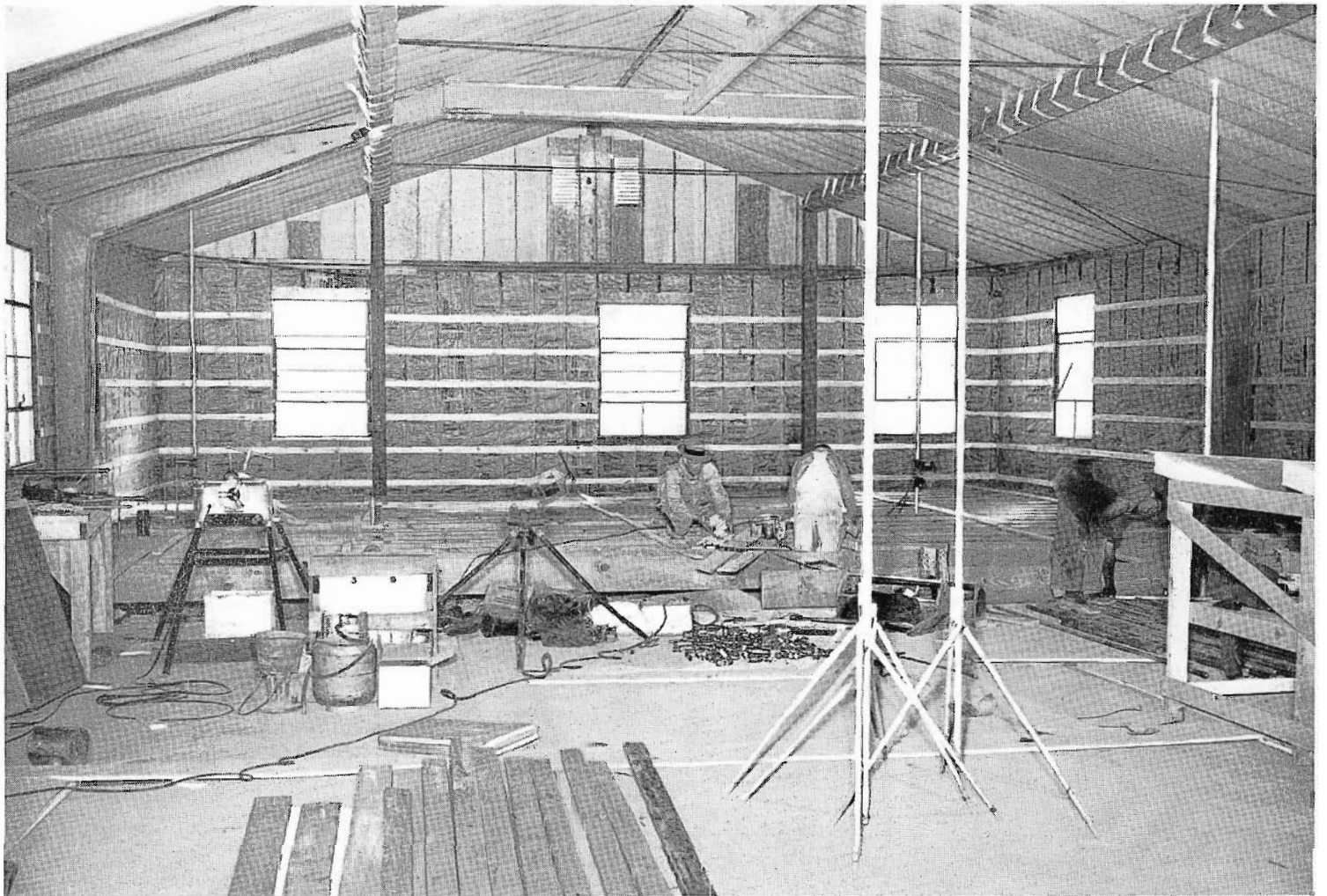

FIG. 5. Interior of the building during construction. All surfaces exposed to outside are covered with 3-incl. fibreglas insulation. The living quarters, which are in the end of the building shown here, have wood floors. The rest of the building has a poured concrete floor.

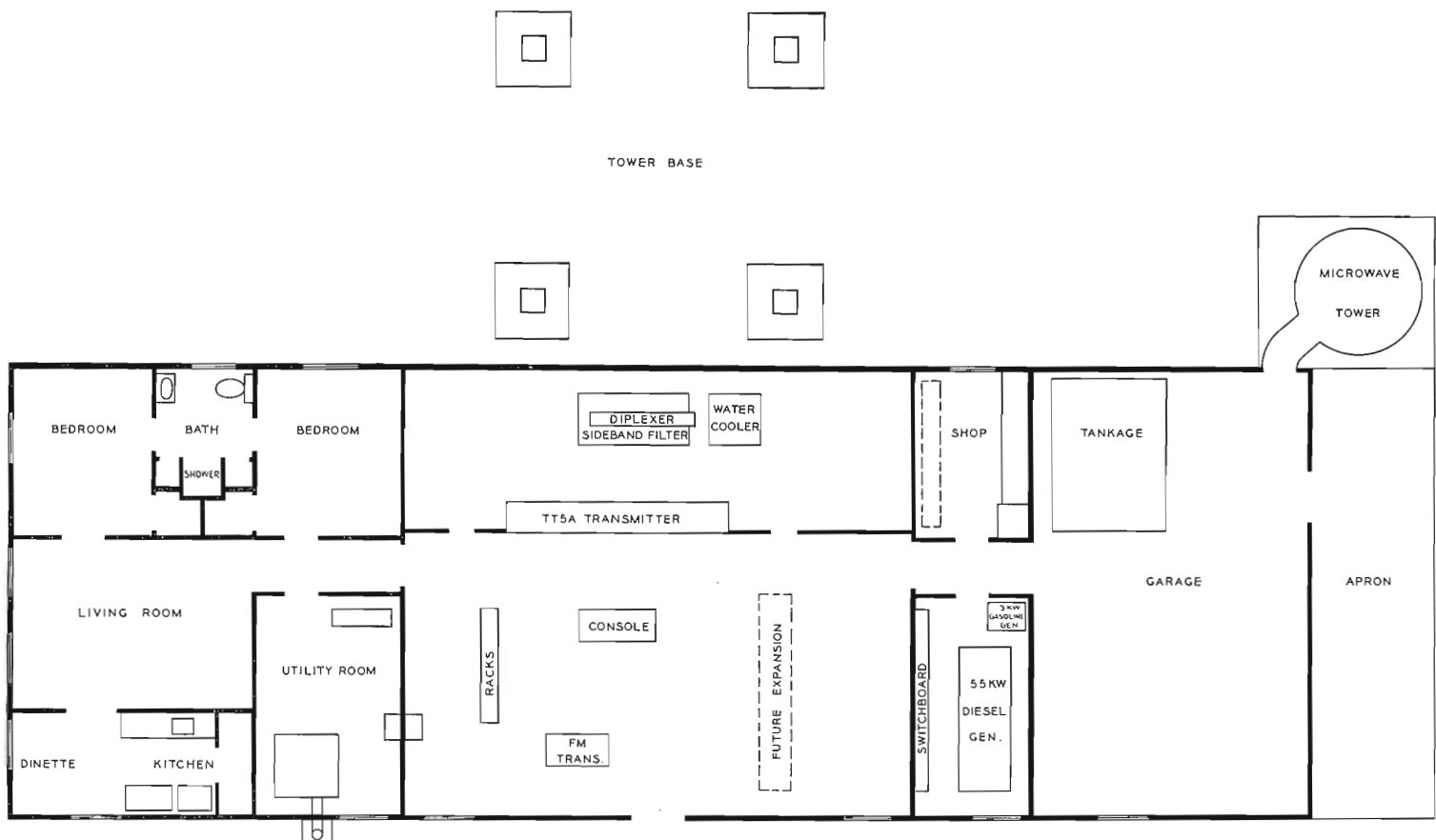

FIG. 6. Floor plan of the KDYL-TV transmitter building on Mt. Vision. The antenna tower is located as near transmitter as possible in order to keep the transmission line short. Note also that inside access to the microwave tower is provided.

## THE BUILDING

The building used to house the equipment is an ARMCO steel prefabricated unit 102 by 36 feet. Steel was chosen for its durability, ease of erection, protection against lightning, and its ability to expand

and contract with temperature changes without developing leaks. It is by far the cheapest type of construction as it can be erected by a few men in a few days, and where manpower has to be transported back and forth daily, travelling time can mount up to a high figure.

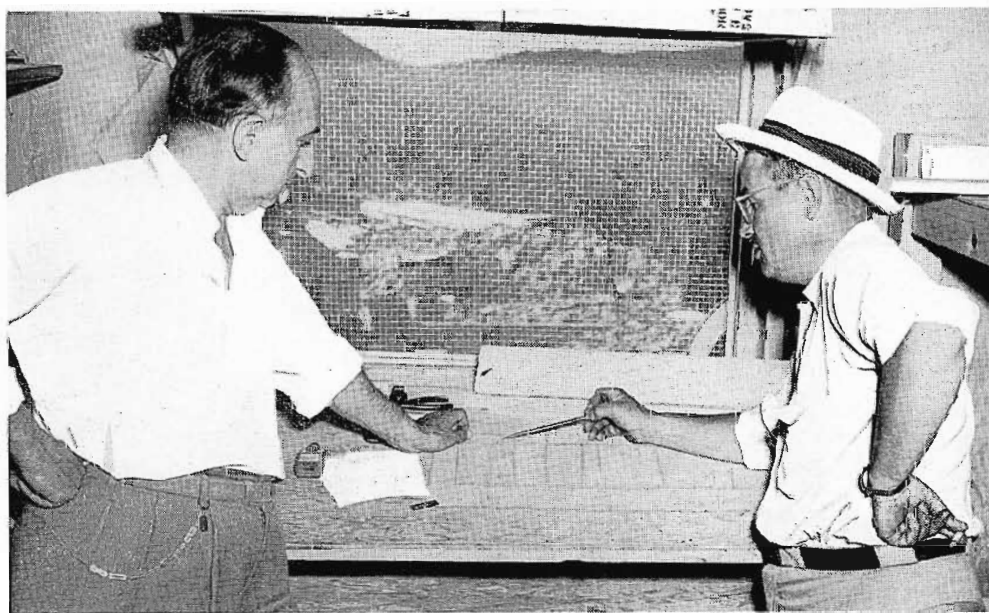

FIG. 7. S. S. Fox, President of KDYL-TV, and J. M. Baldwin, the author, discussing building progress in the construction shack on Mt. Vision.

The building is completely insulated with three inches of Fibre Glass, and the interior finished in wallboard and acoustic celotex. A six room apartment of 1150 square feet is provided for living quarters, and is furnished exactly like a private home would be, with modern electric kitchen, large living room, two bedrooms with adjoining bath, and a large utility room which houses the heating plant, water pressure pump and electric freezer. Heating is furnished by a 200,000 BTU oil furnace, which is considerably larger than necessary, as the insulation of the building prevents heat loss and the television transmitter provides an appreciable amount of radiant heat. The oil furnace burns the same fuel as the emergency power plant, so one supply tank serves for both.

The maintenance of operating personnel at the summit was early recognized by management as being an important problem. Two operators and one general purpose utility man constitute a normal shift. The utility man hauls water, clears snow, performs janitorial chores and in general serves as an all around handy man. The operators divide the day into two shifts, and one being on control duty at a time, but in case of trouble or emergencies, the standby man is instantly available. Com-

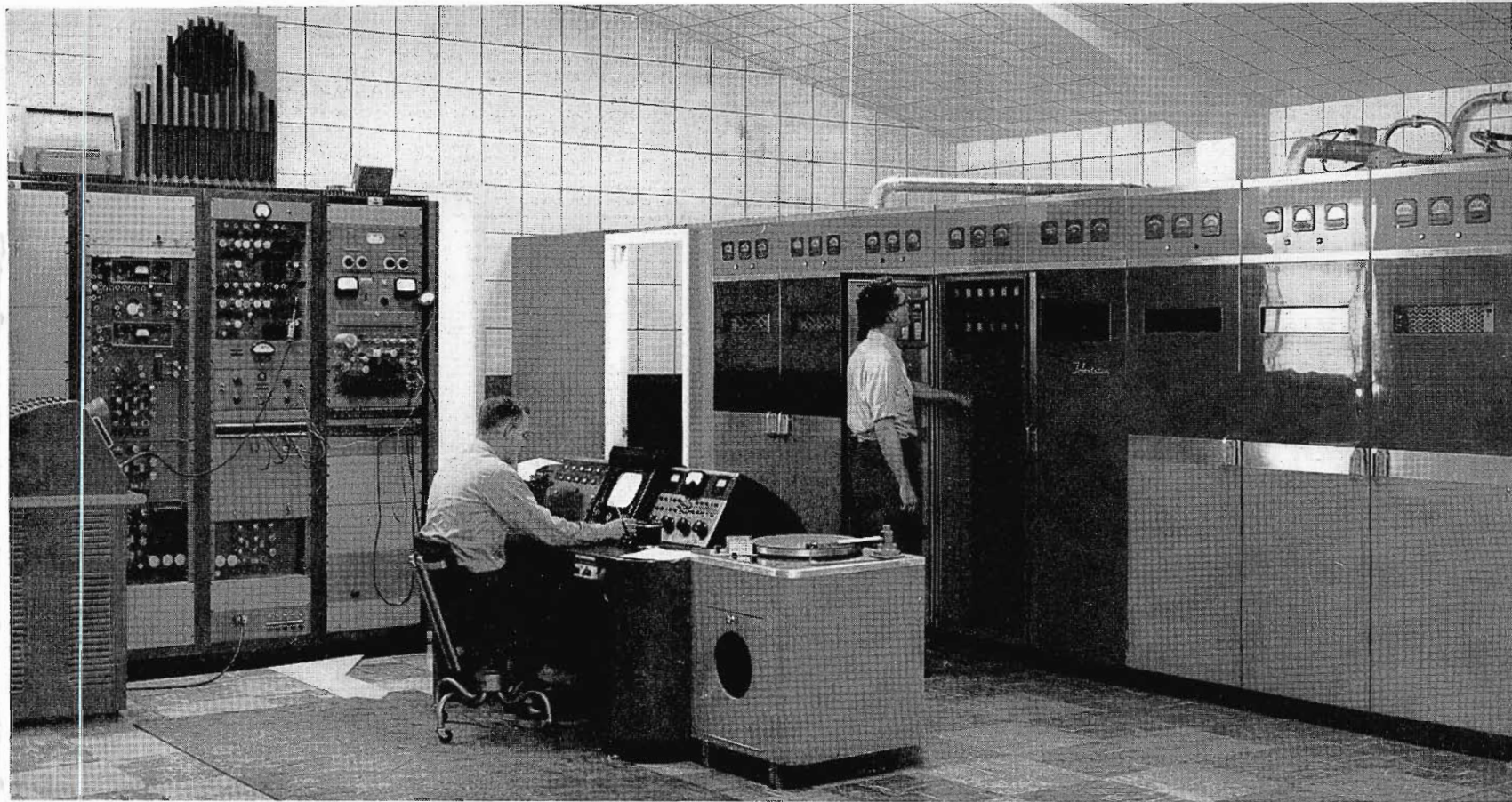

FIG. 8. The transmitter room on Mt. Vision. The RCA TT-5A Transmitter (right) works perfectly despite the rarefied atmosphere. Racks at the left contain video amplifiers, microwave relay receivers and monitoring units. With exception of a few minor units all equipment at KDYL-TV was supplied by RCA.

plete shift changes take place every three days, with a one-day swing shift each week. As the men on duty are completely isolated it was considered important to furnish them with the finest of accommodation and facilities so that their stay on the mountain would be pleasant. Their living quarters are spacious and homelike, and adequate to handle six persons if necessary.

In addition to their regular pay, a food allowance is made, and the company maintains a large stock of canned goods and frozen meats and vegetables at the station to provision the staff in the event the road was completely blocked for a long period. So far it has not been blocked for more than a day at a time.

## POWER AND WATER

Water for domestic and culinary purposes is stored in two one thousand gallon tanks, and the supply is replenished at intervals by a tank truck. This is a temporary expedient, as the snowfall on top is adequate to furnish water throughout the winter months, and a catch basin with electric strip heaters is planned for construction next summer. It is necessary to pay

for considerably more power than is used in order to justify the construction of a power line to the top of the mountain, so the use of electricity for melting water will add nothing to the present power bill. The two water tanks are mounted inside the garage of the building to prevent freezing, and share space with two other tanks, of equal capacity, containing diesel fuel oil.

Emergency power is furnished by a 55-KW generator, with a 3-KW gasoline driven automatic start alternator providing temporary lighting while the diesel is coming up to speed and being switched into the load busses of the plant.

## TRANSMITTER

The transmitter is an RCA TT-5A, mounted on one side of the operating room, which is laid out with extra ducts and plenty of space so that other transmitters can be added later. KDYL-FM is being moved at the present time to the mountain top and will start operation again in the near future. The space to the rear of the transmitter is occupied by spare parts cupboards, and the usual accessories of a TT-5A, such as the vestigial filter, diplexer, and water cooler.

The ground system presented an out of the ordinary problem, as the rock core of the mountain has a high resistance. The usual strips of bonding copper were used in the building, and in turn connected to two cables which were laid to the north and south and carried in trenches down the side of the mountain about 100 feet in each direction. These cables then fanned out in a series of short radials which were terminated in ground rods driven into the shallow overlay of topsoil. Tests showed a resistance of 150 ohms between the north and south groups of radials. This being considerably too high, an old signal corps trick was called into play. Two 55-gallon steel drums, with holes punched in sides and bottom, were sunk in the rock, filled with 50/50 coarse salt and dirt, saturated with water, and connected to the ground system. The ground resistance then dropped to less than 1 ohm and has stayed at that value since. A good ground is just as important for a TV station as it is for broadcasting, as lightning is very prevalent at high elevations, and a direct stroke must be dissipated instantly in a low resistance ground system, otherwise extensive damage can occur.

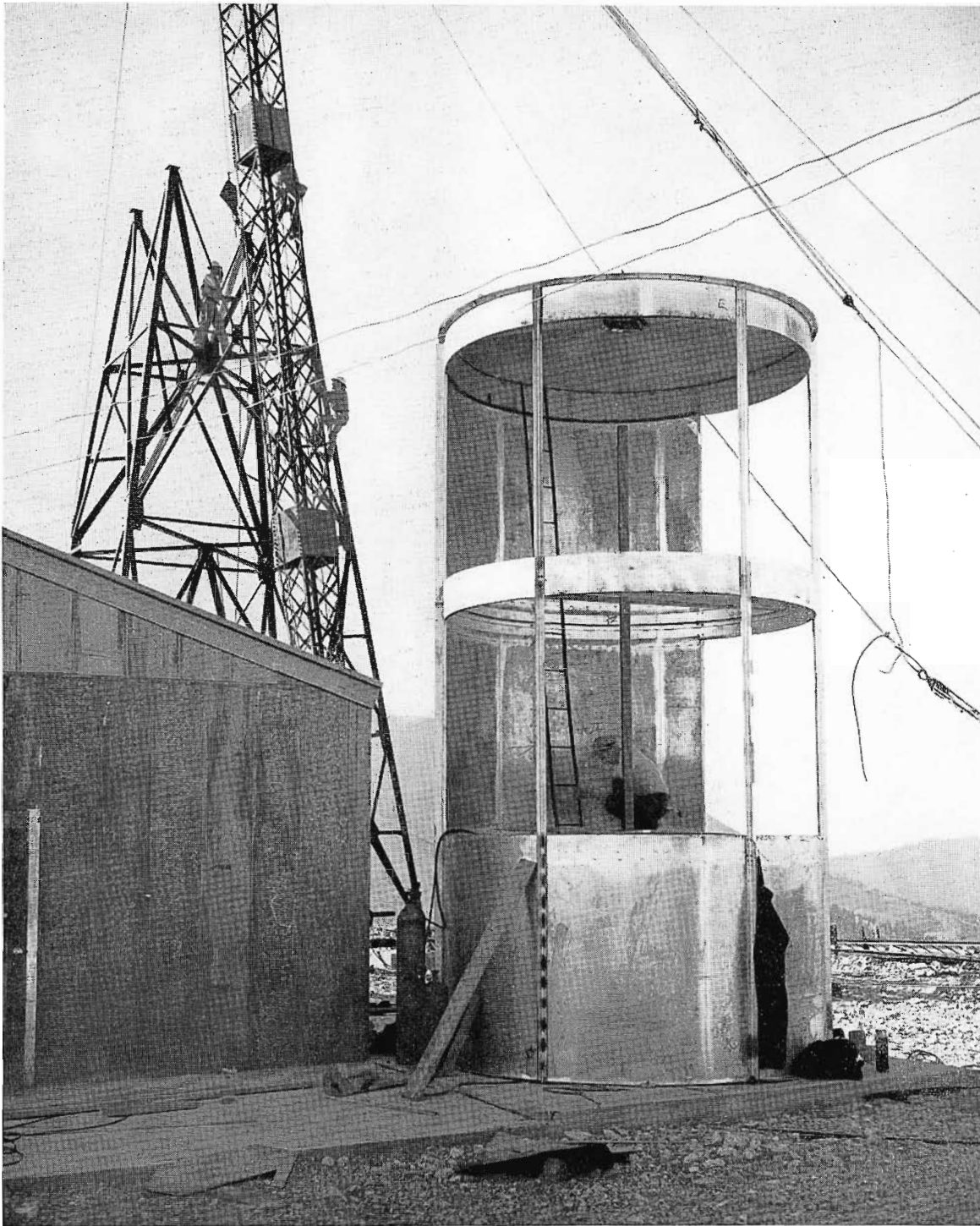

FIG. 9 (left). A unique feature of the KDYL-TV installation is a microwave "tower", shown here during construction. Two station-owned RCA microwave links provide video circuits from the studios in Salt Lake City. The receiving parabolas are mounted at two levels, as shown in the diagram on the opposite page. The enclosure protects them from the weather and makes maintenance easy.

## TOWER AND ANTENNA

The tower for the RCA six-bay Superturnstile was designed and fabricated locally. One hundred feet in overall height, it tapers from a base width of 20 feet to 3 feet square for the last 16 feet. As it is of much heavier construction than is customary in radio work, the designer was accused of being a pessimist, but he was later proven to be right in his pessimism, as a neighboring TV tower on an adjacent mountain was felled by a violent windstorm

which the KDYL-TV tower rode out without incident. No guys are used, as the mountain drops off so sharply that unreasonable lengths would be required, with possible excessive ice loading and wind vibration as a result. The tower is lighted according to standard requirements, but it has been impossible to keep the top beacon light in operation very long at a time, as the wind blows snow into the ventilating openings and breaks the lamp bulbs. Some modifications will be required in the beacon housing to stop this trouble.

## MICROWAVE FACILITIES

An interesting feature of the plant is the provision for microwave service from Salt Lake City. The site is so far from existing telephone circuits that all communication and program channels are provided by station owned equipment. Two RCA microwave links are provided for the picture relay, both operating on the same frequency, but capable of carrying different program material due to the use of horizontal and vertical polarization. When carefully adjusted these links operate with-



FIG. 10 (right). The construction of the silo-like microwave tower is shown in these drawings. The sections of the enclosure through which the microwave signals are received are made of 1/4-inch plywood. The plywood panels are clamped to the steel uprights as shown at the lower right. A covered passage-way to the main building provides for maintenance or reorienting of the parabolas in even the worst weather.

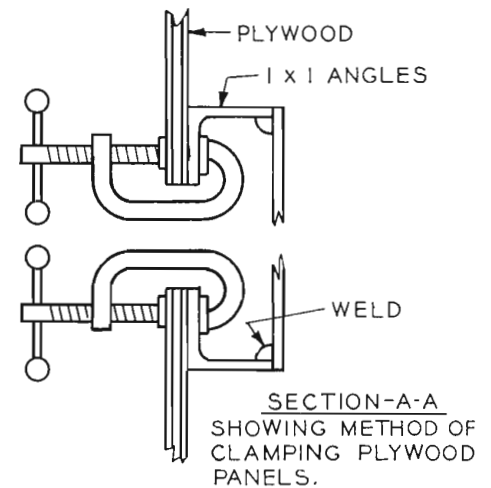
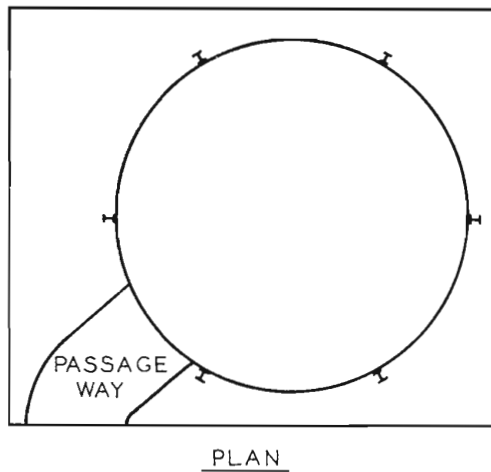
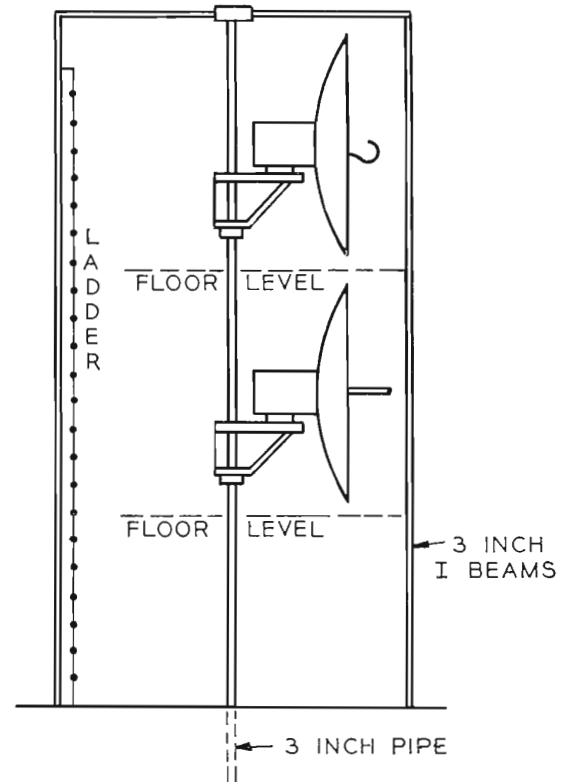
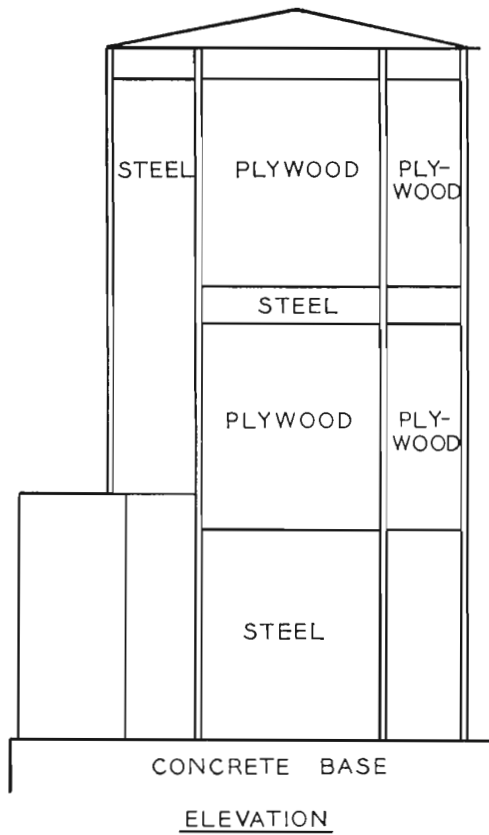

out crosstalk. A 2-watt RCA STL provides the sound channel, and in case of difficulty, either of the video microwave links can be used as a spare sound service through appropriate patching at the control rack.

The microwave units (video) are housed in a special tank-like structure adjacent to the main building, connected by a closed passageway. This tank has two levels, and the microwave receiver units are mounted on swiveled carriages revolving around a center pier, so that they may be rapidly re-directed to pick up programs originating at remote points. The sides of the tank are

covered with 1/4-inch plywood at the two levels through which the microwave signals are received, this plywood extending for 270 degrees around the circumference of the sides. Plywood has extremely great strength when bent and the tank panels have been unaffected by the high velocity winds experienced this winter. They are treated with linseed oil and turpentine to preserve them against the weather, in lieu of paint, which generally having a metallic base, would be unsuitable by reason of attenuation presented to the microwaves.

## CONCLUSION

In conclusion, we wish to acknowledge with appreciation the help given by Jack Sneedon and Keith Hopkins of the KDYL engineering staff, who ably assisted in supervision of the construction; to Allen Gunderson and Ralph Silvers, who installed the transmitting equipment; to R. V. Porter, of the RCA Service Company, who supervised the antenna installation, and above all, to S. S. Fox, President of KDYL-TV, for his counsel and encouragement during all phases of the project.

# THE TP-6A . . . *A New 16mm* PROFESSIONAL TV PROJECTOR

by **H. G. WRIGHT**  
TV Projector Engineering  
Engineering Products Department

According to one source of information, 25 million dollars has been budgeted for telefilm productions alone, in 1953. Because of this steadily increasing usage of film program sources, the introduction of the new, heavy-duty RCA TP-6A projector is an event of consequence and timeliness. This new projector is a result of many years of close contact with the broadcasters' needs and problems along with increased technical knowledge and experience. The result is a truly professional projector designed specifically for use by the television broadcaster.

#### Major Parts of Film Projectors

Before describing the TP-6A projector, a description of the four major parts of any film projector using an intermittent film motion is in order. Essentially, this type of projector can be broken down into these major units:

1. The projection optical system.
2. The film transport system.
3. The sound reproduction system.
4. The control system.

Fig. 4 shows a diagrammatic representation of the first three systems.

#### Optical Systems

The projection optical system operates in the following manner. Light produced by the projection lamp is intensified by the reflector and focused by the condenser lens system in a flat or uniform intensity field at the aperture. The shutter, when rotated, effectively turns this light on and off. The projection lens focuses the image of the illuminated frame of film on the screen. The shutter must be accurately phased with the intermittent motion of the film so that the light is never on when the film is being moved. If the light pulse occurs when the film is being moved, a blurred image called a "travel-ghost" results.

#### Film Transport

The film transport system can be seen in Fig. 4 and functions as follows. The

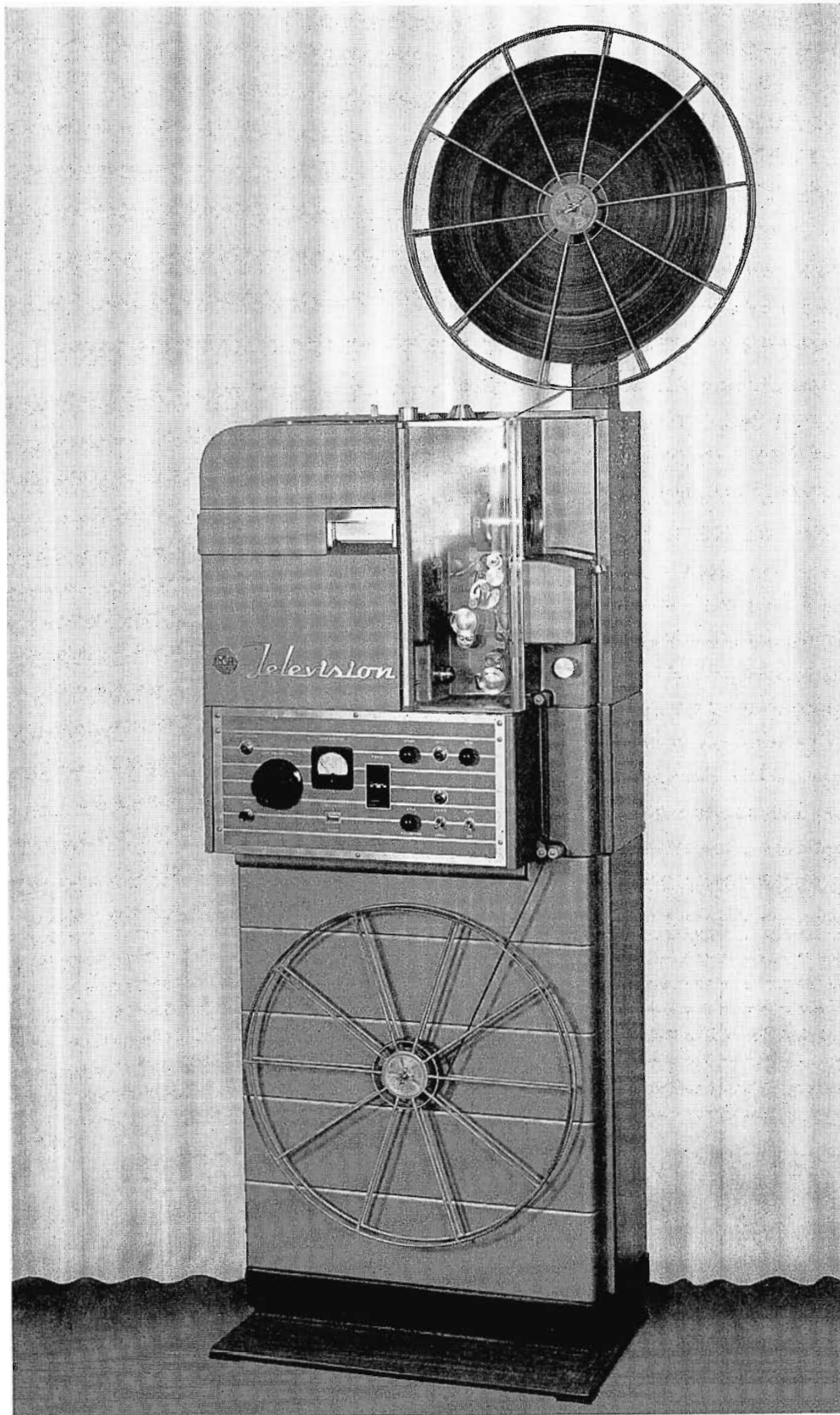

FIG. 1. The new RCA Professional Projector (TP-6A) which provides advanced operational and electrical features plus 4000-foot reels for uninterrupted programming.

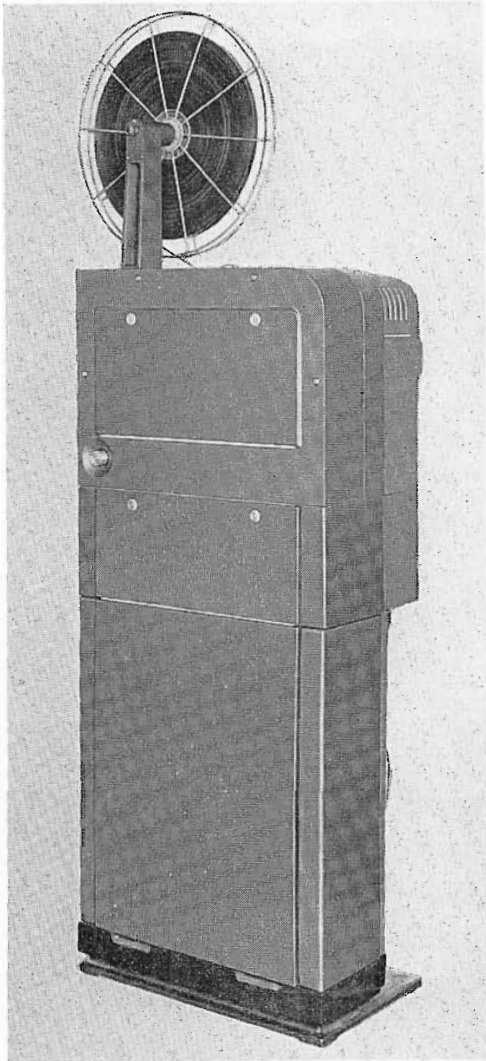

FIG. 2. Full rear view of the TP-6A Projector.

film is pulled from the supply reel by the upper feed sprocket and delivered to the gate. The intermittent device for moving the film in this diagram is of the claw type. The claw, traveling in a rectangular path, moves the film intermittently. The film is held flat by a pressure shoe and at this point is accurately guided. After leaving the gate the film is led to the sound reproduction system and then to the take-up reel.

### Sound Reproduction

In the sound reproduction system, light from the exciter lamp is focused by the sound optical unit in an extremely thin line at the film plane. The film is held in close contact with the sound drum by the pressure roller. A heavy flywheel and a damped roller smooth out the rotary motion. The light passes through the film and is modulated by it. The modulated light beam is conducted to a photocell and the output of the photocell is fed to a preamplifier.

FIG. 3. Model layout showing the use of two TP-6A Projectors in a typical TV projection room.

### Control

Almost all projectors are made up of some form of the aforementioned three systems as well as some form of control system. With the differences outlined later, television projectors usually include these four major units.

### Solution of Basic Problems

The television projector designer is faced with some basic differences between a standard projector and a video projector. The fundamental problem stems from the difference in the standards of the motion picture industry and the video broadcasting industry.

The motion picture industry utilizes a 24 frame per second projection rate. The video signal however, is keyed to the most widely used power source of 60 cycles per second. The use of interlacing results in the production of 30 completely scanned pictures per second. Here then, is the basic problem. The projected picture at a 24 frame per second rate must be converted into a video signal at a 60 field or 30 frame per second rate. In Fig. 5 a time sequence of a standard 16mm motion picture projector is compared with the television scanning cycle. Note that if the conventional shutter and pulldown was used, incomplete picture information would be presented to successive television scanning periods. If the shutter was removed entirely, pulldown of the film would occur during the scanning interval resulting in "travel-

ghosts." Since the time required for pull-down is greater than the vertical blanking or retrace interval, it is impractical to use a conventional pulldown and shutter sequence. The method most widely used to circumvent this problem is shown in Fig. 6. A storage\* type of pickup or camera tube is used. Light is flashed on the camera tube only during the vertical retrace period and the stored image is scanned in total darkness.

In line "A" of Fig. 6, the projector time sequence used on the RCA TP-16 series of projectors is shown. The pulldown time of a standard projector is shortened and this enables the *evenly spaced* pulldown periods to be placed so that two light flashes occur during one frame and three light flashes in the next, etc. At the end of ten light flashes, four frames have been projected while ten television fields or five television frames have been generated. This ratio of 4/5 is the same as 24/30. In line "B" of Fig. 6, a similar method used on the RCA TP-6A projector is shown. Here the pulldown spacing is *unequal* in a 2/3 ratio. In the first interval two flashes occur and in the second, three flashes occur as in the sequence above, but the 2/3 spacing allows a longer pulldown time and its location anywhere between vertical retrace periods.

\* "Storage" is the ability of the pickup tube to momentarily retain the photo-electric charge image, corresponding to the light image, flashed on its light-sensitive surface.

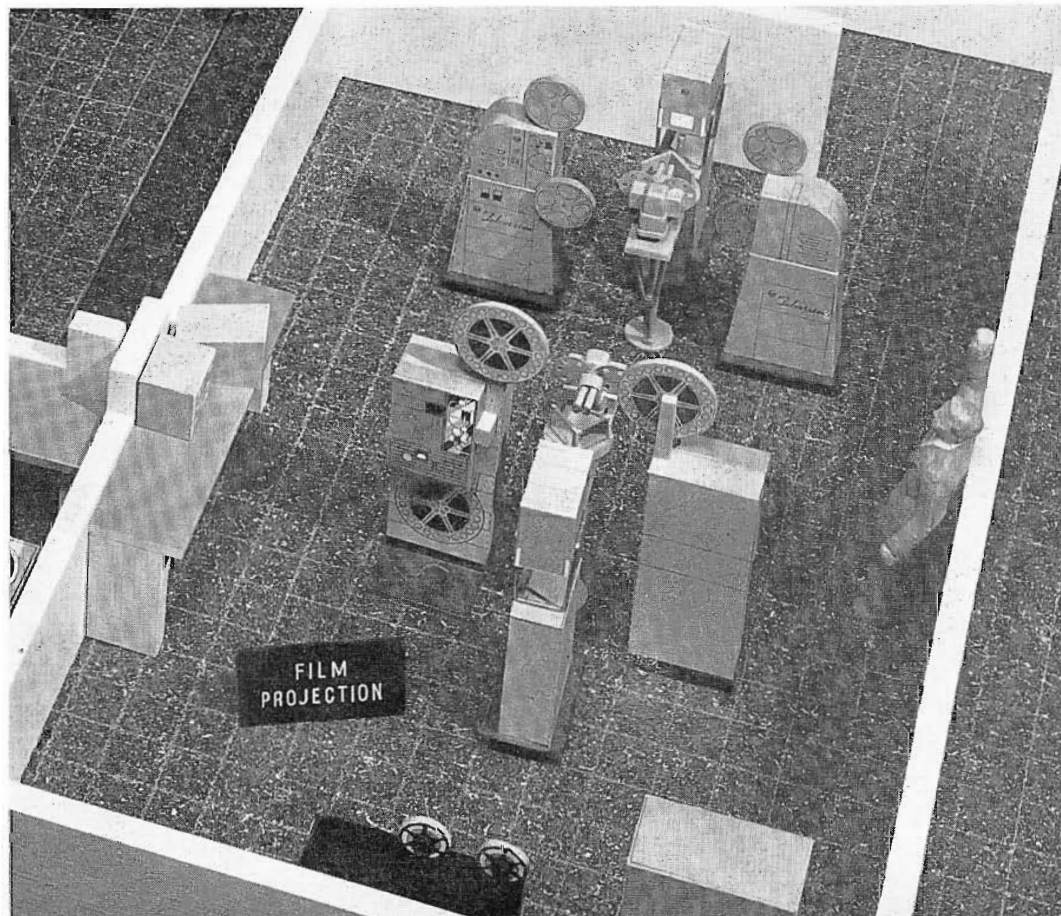

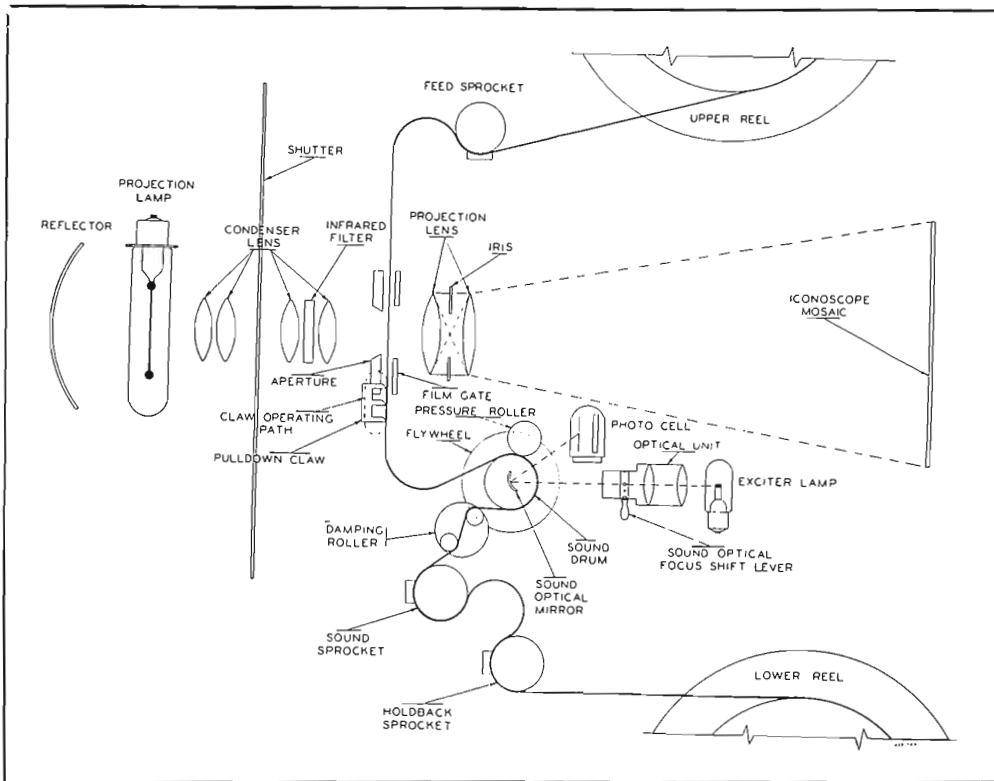

FIG. 4. Functional diagram of the TP-6A 16mm Projector showing optical component arrangement.

A fourth requirement is that the light pulse produced must be of sufficient intensity to produce a usable picture on the camera tube and must not fall on the tube during the scanning period. This necessitates a highly efficient shutter and condenser lens design and accurate phasing of the shutter rotation with the camera sync.

generator. If the light falls on the tube during scanning, a horizontal bar of light called an "application bar" is formed.

Some additional features required of television projectors include long life, easy maintenance and the means for rapid replacement of lamps which are subject to failure. The picture must be as steady as it can be made, and the sound must be of high quality. Tight scheduling of programs requires fast starting. Efficient programming often requires the remote operation of the projector and this too must be included.

### The RCA Professional Projector

The RCA TP-6A projector was designed to give high-quality pictures and sound from standard 16mm sound motion picture film. The equipment specifications cover the television broadcaster's requirements in a most satisfactory manner. The machine is a complete self-contained unit including projector, preamplifier, pedestal and con-

### 16 MM STANDARD PROJECTOR

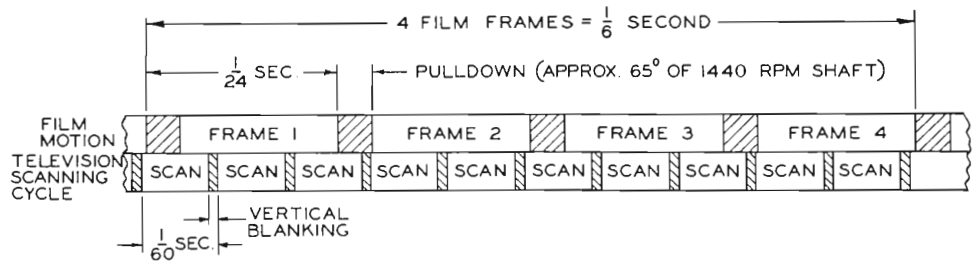
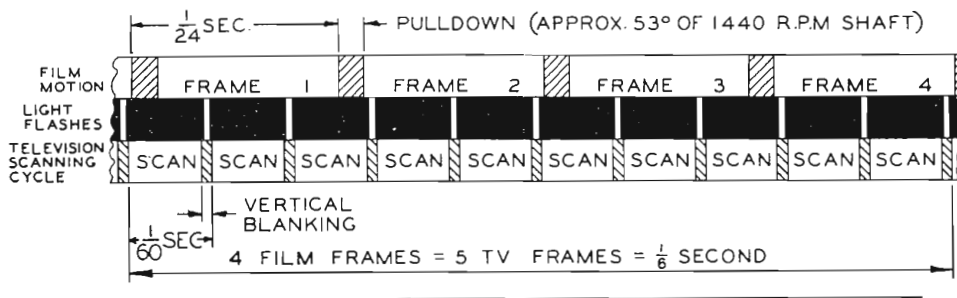

FIG. 5. Time cycling of a standard 16mm projector.

### (A) 16 MM TELEVISION PROJECTOR TP16 (EVENLY SPACED PULLDOWN)



### (B) 16 MM TELEVISION PROJECTOR TP 6 (2-3 PULLDOWN)

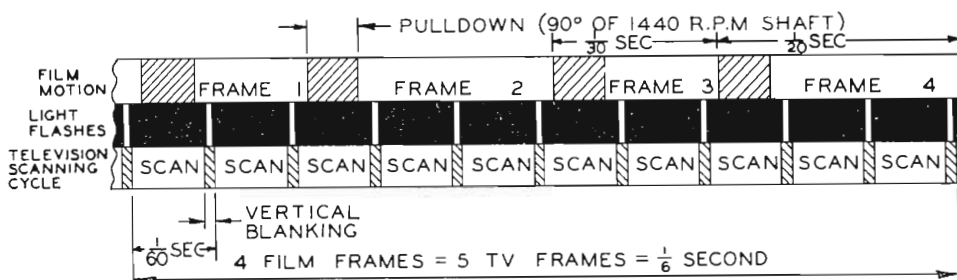

FIG. 6. Sketch showing time cycle comparison of TP-6A Professional Projector with that of the TP-16 Projector.

trols. The requirements of long, trouble-free life and easy maintenance have been given special attention.

### Projection Optical System

The projection optical system has been designed to give an adequate amount of light. The projection lens is an f1.5, 3 1/2 inch focal length, 7 element lens, especially designed for the short throw distance used with the iconoscope film camera.

This lens has high resolution and good contrast. The lens is fitted with an adjustable iris for controlling the intensity of the light pulse. The mounting for the lens consists of a barrel which holds the lens and slides on ball bearings for focusing the projected image. A rigid casting mounted to the main frame provides the support for this barrel. The projection lens is not moved for the threading operation. Focusing is accomplished through an anti-backlash worm gear drive. Focusing control knobs are placed on both sides of the projector. This allows the image on the mosaic of the film camera to be used for focusing

when the projector is on either side of the film camera. The film gate will be discussed later. However, in connection with the projection optical system, the standard ASA effective aperture size of .380 x .284 inches is used. The optical components are shown in Fig. 7.

The specially designed condenser lens system can be seen in Fig. 8. The system is quickly removable for cleaning. The mounting brackets are designed to insure optical alignment when the housing is removed and replaced. The condenser lens system is of the relay type and produces a light spot of about  $\frac{3}{8}$  inch diameter between the two sets of lenses.

The shutter cuts the light at this point and the minuteness of the spot gives high efficiency. The front section of the condenser lens system is fitted with a red and infra-red filter. Along with the shutter, this filter helps to keep the gate temperature down but it has another important function. When this filter is used, pictures produced from monochrome film show increased resolution and contrast while pictures produced from color film on a monochrome film camera chain are free from disturbing haze.

The shutter, made of magnesium, is enclosed in a cast housing and is driven by a special 3600 RPM synchronous motor. This motor utilizes a permanent magnet rotor to insure lock-in of the rotor in only one place. The motor can be phased by rotating the motor frame in its trunnion supports. On the shutter housing is mounted the changeover or dowsner mechanism.\* This operates in the conventional manner using two solenoids to move the dowsner which interrupts the light path. Manual operation is also possible, and the handle can be reached from either side of the machine.

#### **Projection Lamp Change (Less than 1 Second)**

One of the most distressing worries in the projectionist's life is the failure of projection lamps. While some means of quick change alleviates the problem, there is still an appreciable length of time before the change can be made. With this difficulty in mind, an automatic projection lamp change mechanism has been designed which practically eliminates emergency

\* When a complete film is placed on two or more reels this changeover shutter, used in conjunction with cue marks on the film and some form of audio switching, allows switching from one projector to another without interruption to the program.

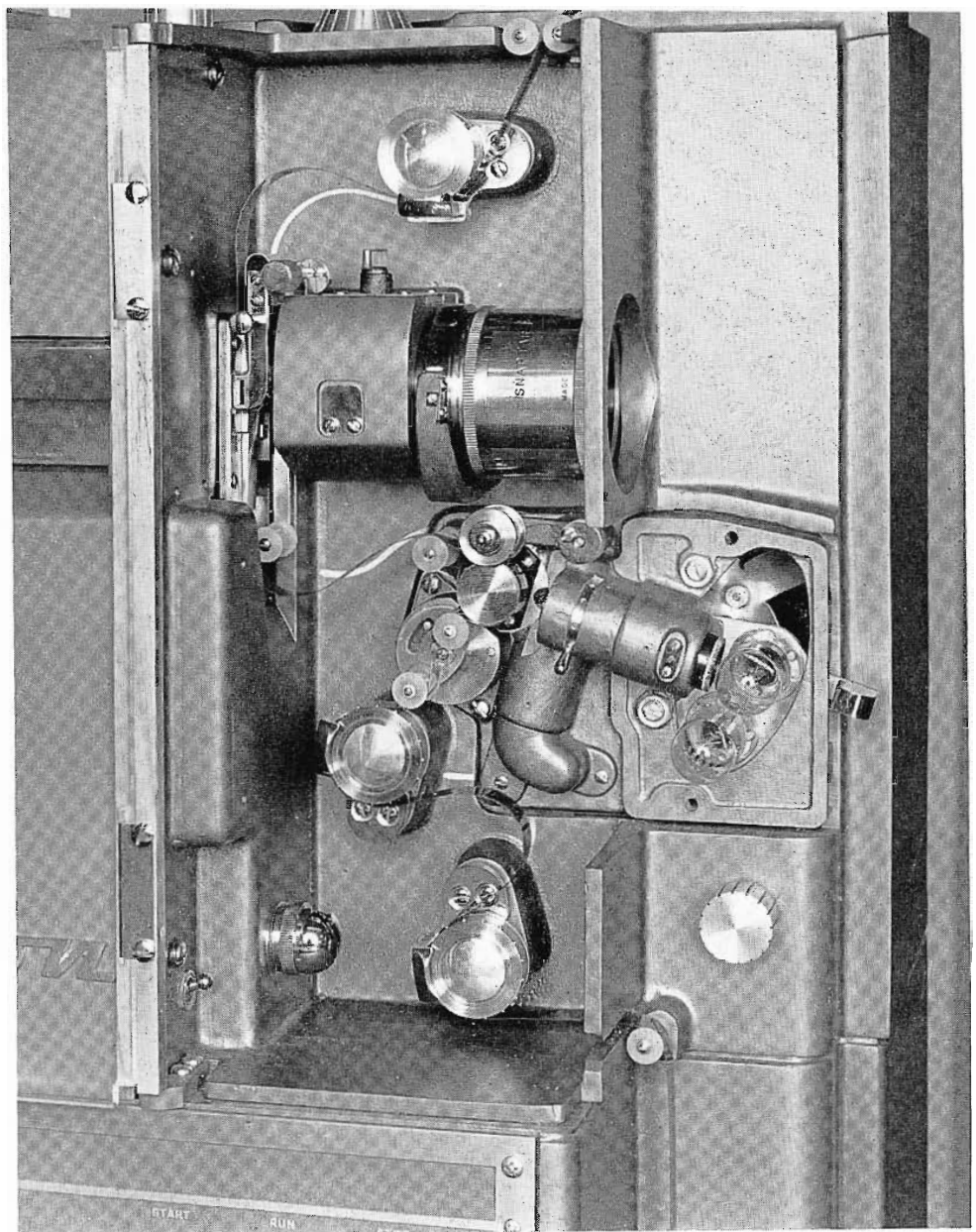
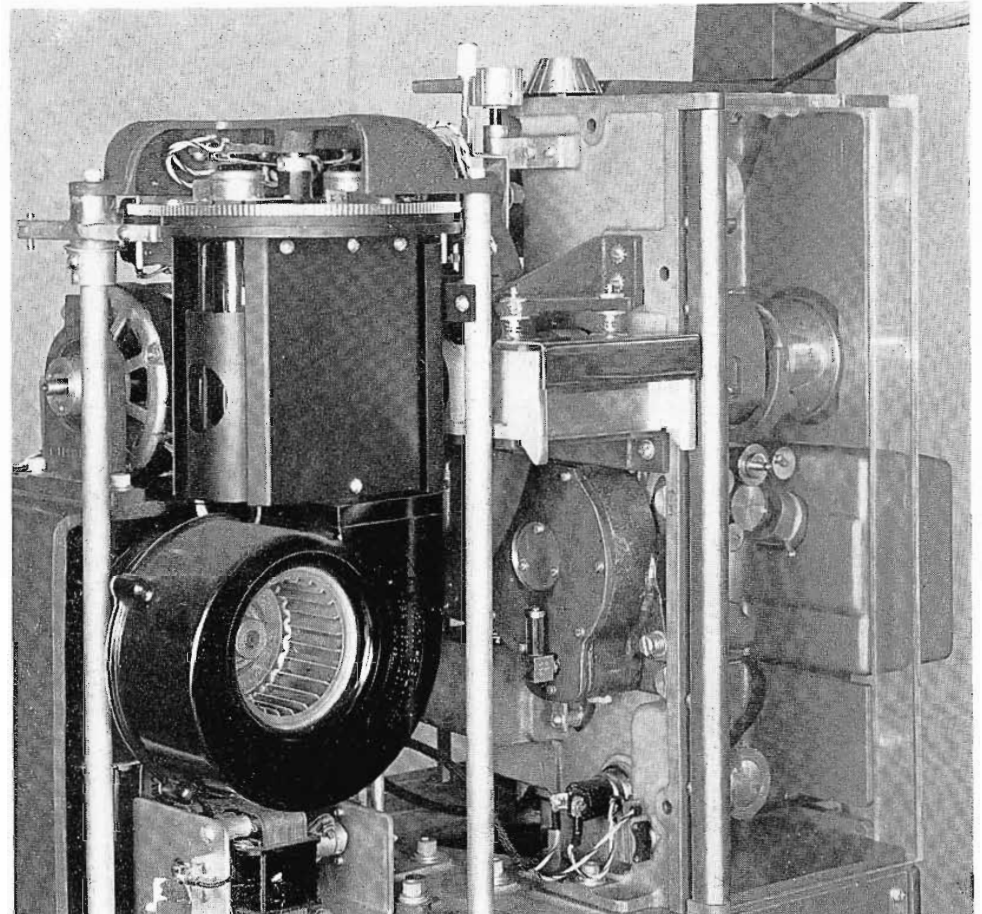

FIG. 7. View of the TP-6A Projector showing the optical components, film path and focus controls.

FIG. 8. Top cover is removed in this photo to illustrate condenser lens system and blower assembly.



lamp change problems. The entire operation, from the failure of one lamp to the automatic replacement of a new lamp, takes place *in less than one second*. The effect when viewed on the monitor screen is negligible.

Fig. 8 illustrates the automatic lamp-change assembly. Two lamps are mounted in a rotating mount, each with its own spherical pyrex reflector. The lamps are of the 1000 watt, tungsten, base-up type. The lamp in use is cooled by a blower situated directly beneath it. A relay coil is connected in series with the projection lamp filament. When this circuit is broken by a filament failure, the relay completes the circuit to a motor driving the lamp assembly and to a solenoid operated detent. A limit switch operated by the rotation of the lamp assembly breaks the circuit and remakes the circuit when the rotation is complete. The inclusion of this switch prevents arcing when the new lamp meets the heavy current contacts. In its travel to the projection position, the new lamp passes under an additional set of contacts which preheat the lamp as it goes by. When the new lamp reaches the projection position, it is lighted by the operation of the switch. The motor stops and the detent falls into place. The faulty lamp can be replaced through a door in the cover while the machine is operating. Included in the control system described later is a variable transformer and a voltmeter to allow the operation of the lamp at or below rated voltage. Since this automatic change of lamps takes place in such a short time and might be overlooked, a pilot lamp is provided which indicates when a change has been made.

Another important feature is made possible by the optical components described. With a low gate temperature produced by the shutter and filter and the separate motor drive of the shutter, "still" or "stop-frame" projection is possible. This allows the adjustment of the film camera using a stationary scene.

### Film Transport System

The film transport system has been designed with five major objectives in mind.

1. The projected image must have the least amount of horizontal and vertical unsteadiness possible.
2. The machine must lend itself to fast threading, a most important feature to the television broadcaster faced with tight scheduling.
3. Damaged film and splices should have as little effect as possible on the operation of the projector.

4. The projector should be designed so that film scratching and emulsion pile-up is at a minimum.
5. The machine should have long operating life.

The sprockets are driven by precision helical gears from a 3600 RPM shaft. The shaft is attached through a flexible coupling to a vertically mounted synchronous motor utilizing a permanent magnet rotor for lock-in similar to the shutter motor. This motor is also phased by rotating the motor housing in its trunnion supports. All of the gearing is contained in cast housings with oil bath lubrication.

Ample room is available around the sprockets for threading, and a new sprocket shoe design allows the film to be slipped into place easily. A hold-back sprocket is provided to prevent take-up reel disturbances affecting the motion of the film at the sound drum.

As stated before, the projection lens is not moved for the threading operation. The gate only is opened by pressing a small lever mounted on the top of the lens mount casting.

The aperture plate, the fixed film guide, and the film pressure shoe are plated with long-wearing, hard, chromium and polished to a mirror finish to reduce the possibility of emulsion pile-up and scratching. The side pressure shoes are lined with sapphire to eliminate wear. Adjustable pressure on the film shoe furthers the elimination of damage to the film when freshly processed film is used. This adjustment is made by turning a calibrated knob at the top of the gate and can be accomplished while the projector is running.

The intermittent or pull-down mechanism is the result of a careful analysis of the relative merits of many types of intermittent devices. Some of the factors considered were: The stability of the projected image and the effect of manufacturing tolerances on this stability and on the replacement of parts: The behavior of the system using worn and damaged film. This careful investigation resulted in the design of a new claw type intermittent of the 2-3 type. The time cycle produced by this intermittent is shown in Fig. 6, Line B. An exploded view of the basic parts of the intermittent is shown in Fig. 9. Here can be seen the two cams which give the claw its rectangular motion. The up and down cam is shown with the claw body and follower in the cam groove. The two pulldown points are separated by  $144^\circ$  which gives a ratio of  $144/216$  or  $2/3$  in the timing of successive pulldowns. Rotating this two-pulldown cam at 720 RPM moves the film at a 24 frame per second rate. The center portion of the claw support is made of spring steel which allows the flexure required for horizontal motion produced by the in and out cam. The claw travels in grooves in the claw guide while the claw guide moves along rails in the intermittent housing. This combination of cams can be manufactured to reasonable tolerances and gives a vertical unsteadiness of less than .1% of the picture width. Because of the 2:3 spacing of the pulldown periods, the actual time of pulldown can be lengthened over the time required for an equally spaced intermittent as described above. This increased pulldown time results in increased life of the parts of the intermittent and of the film. Another factor giving increased life is the oil bath lubrication.

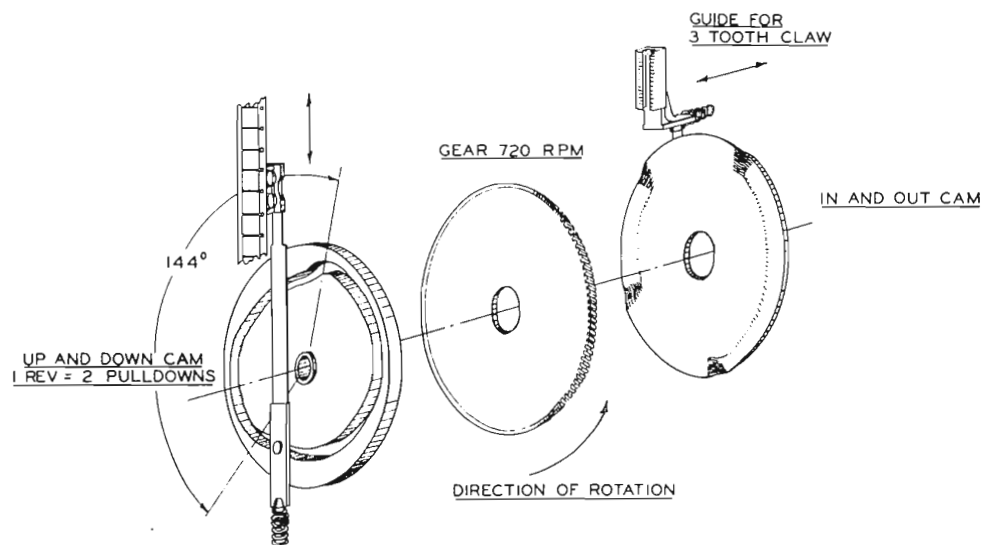

Fig. 9. Diagram showing an exploded view of the TP-6A intermittent.

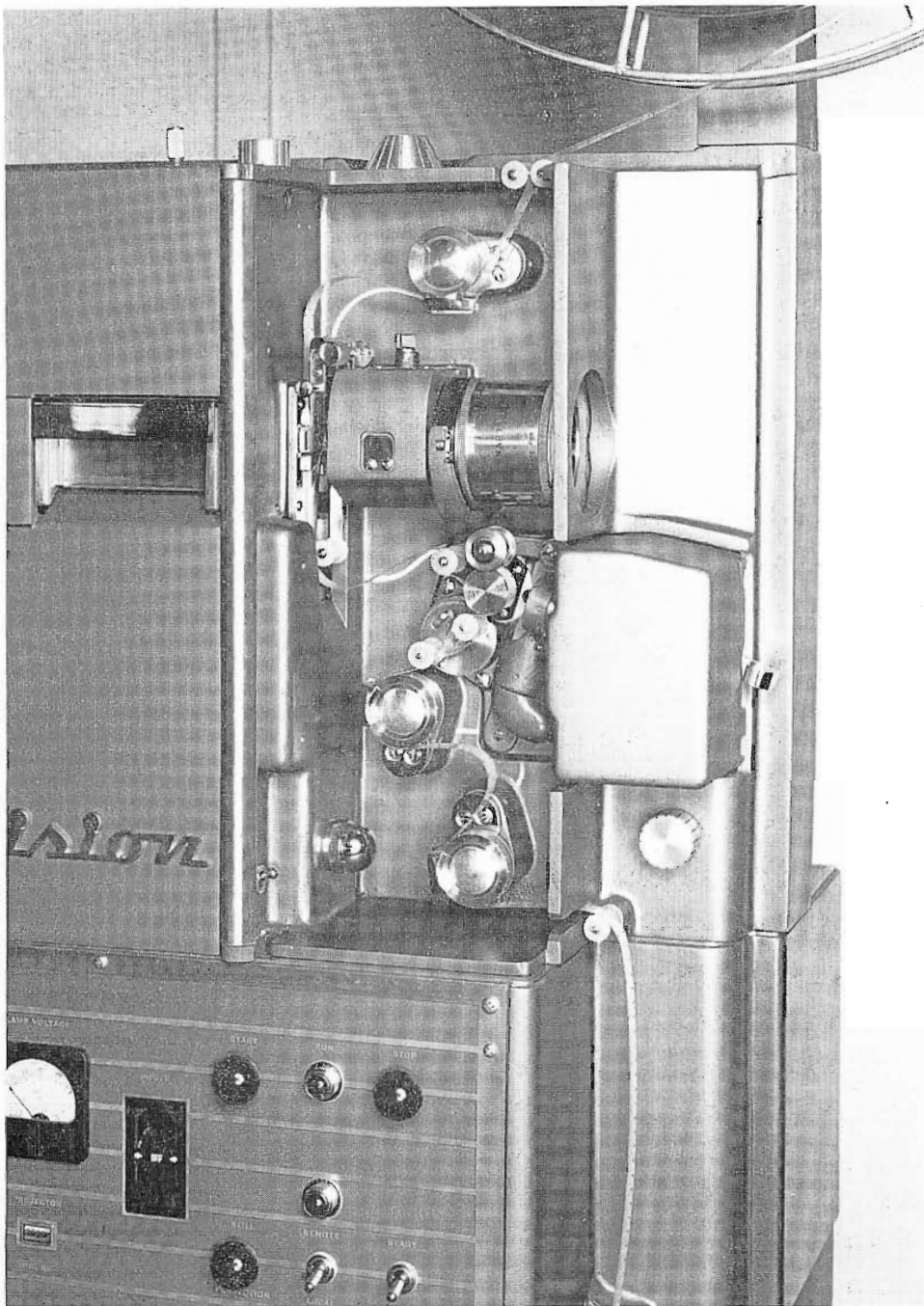

FIG. 10. Closeup view of the TP-6A sound reproduction assembly.

The use of a claw type intermittent makes possible the restoration of a lost loop due to damaged film by simply pulling the film back to its original position while the projector is operating.

The claw is equipped with three teeth for the uninterrupted passage of film with several damaged sprocket holes. The upper tooth is lined with sapphire for long life.

Framing of the picture is accomplished by moving the intermittent assembly up and down. The shaft and knob for this adjustment is brought to the top of the projector making it accessible from either

side of the machine. A manual turn-over knob for checking the threading is also located at the top of the machine.

On the shaft of the supply reel is a friction device used to adjust the tension in the film. The take-up device is a weight compensated friction clutch mechanism which will handle reels from 400 feet to 4000 feet capacity. Film tension of from 10 to 5 ounces is maintained by the take-up.

FIG. 11. Rear view of TP-6A with panels removed to show rack type assembly of power chassis and preamplifier.

The film threading compartment is covered with a transparent plastic door to allow inspection of the film path and to keep dust and dirt from entering. The other covers over the mechanism can be removed easily for servicing.

### Sound Reproduction System

The sound reproduction system can be conveniently separated into mechanical and electrical features. Fig. 10 shows the mechanical assembly of the sound bracket. This entire assembly is shock mounted from the rest of the projector mechanism. On this bracket, two exciter lamps are mounted in such a way that upon failure of one, the emergency spare can be placed in operation by pressing a lever. This lever extends outside of the cover and the change operation can be performed while the machine is in operation. Exciter lamps of a new design are used. The lamps are operated with DC and are rated at 10 volt, 5 amperes. They are horizontal mounting lamps with an internal heat diffusing screen to reduce darkening of the glass. The optical system is similar to the mechanical aperture optical system employed in the RCA film recorder. This system produces a .0005 inch thick slit of uniform intensity. A small lever adjusts the focus of the optical system for emulsion on either side of the film. After passing through the film, the light is collected by a spherical mirror and reflected to the photocell.

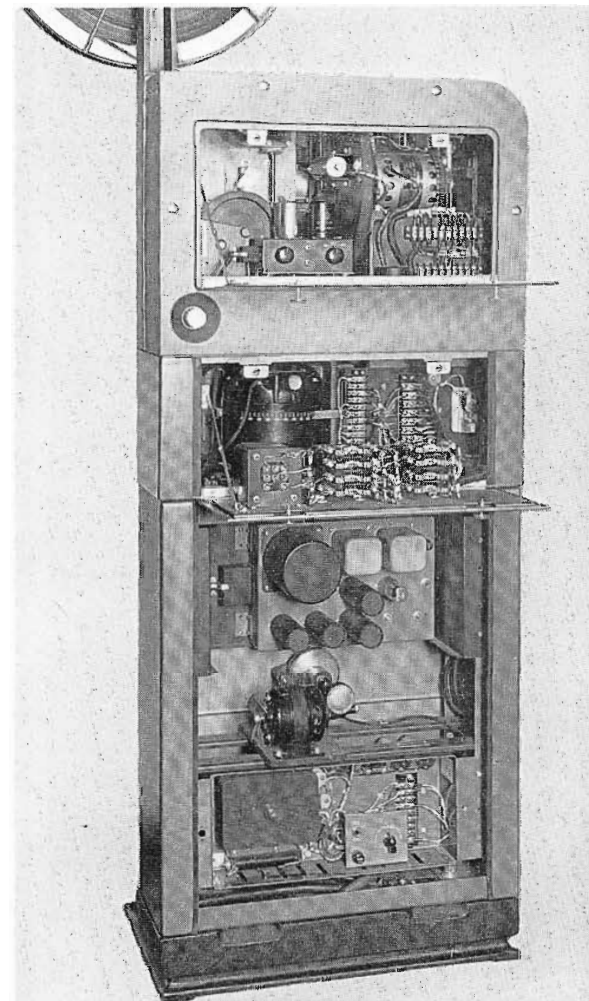

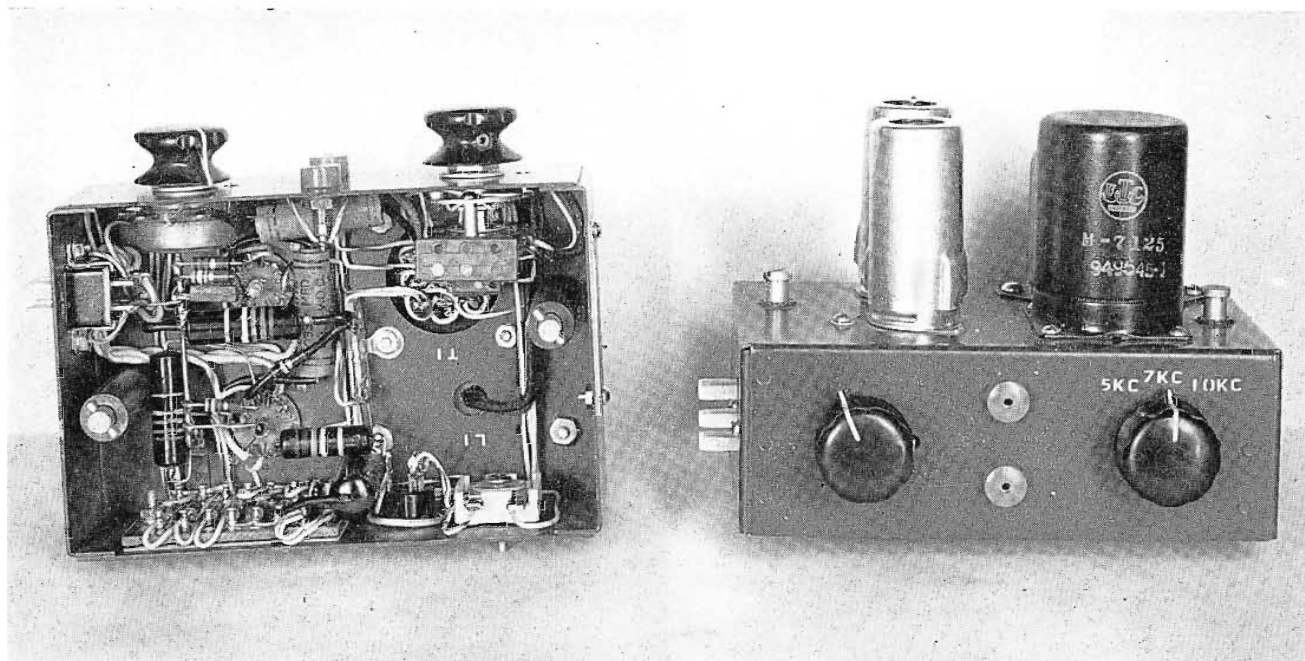

FIG. 12. Under-chassis view and front view of preamplifier chassis.

The film motion at the sound drum is made uniform by the use of an accurately balanced flywheel and a dampening roller assembly using viscous damping. The design of this damping assembly is such that a minimum of fluctuation at start occurs. Careful attention to the design of these components has resulted in a flutter specification of .15% RMS average with .25% RMS peaks. The pressure roller is a new design which uses viscous damping to provide a tight loop around the sound drum. A flywheel "kicker" and brake are provided to decrease sound stabilization time. Usable sound is available two seconds after starting. The brake on the flywheel also prevents the film from rubbing the nose of the optical system when the projector is stopped.

The electrical components of the sound system are designed to give broadcast quality sound. The preamplifier utilizes a 12AY7 for the first stage and second stage. A 12AU7 is used as a push-pull output stage. A tertiary winding in the output transformer supplies feedback to the cathode of the second stage. The volume control is between the first stage and the second stage. Adjustment C3 is provided for high frequency compensation of slit loss. Fig. 11 shows the preamplifier in place while Fig. 12 shows two views of the chassis. Shock mounts are used beneath the chassis and it is a plug-in type unit. The preamplifier is designed specifically for the slit width, photocell and exciter lamp combination used. Output impedances of 150 or 600 ohms are available. An output of 0 dbm can be attained using 80% modulated film with  $8\frac{1}{2}$  volts on the

exciter lamp and with the volume set at approximately  $\frac{3}{4}$  of its total range. This output level can still be maintained with 20% modulated film by increasing the volume and the exciter lamp voltage.

The quality of sound on 16mm film can vary from poor sound on old film to excellent sound on newer film, the great improvement due to technical advances. With this fact in mind, the preamplifier has been provided with three high frequency attenuation points: 5000, 7000, and 10,000 cycles per second. The control for this cut-off point and the control for setting the level are conveniently located. Tip jacks are provided for measuring the output of the preamplifier. The frequency response attained using SMPTE Multifrequency Test Film is shown in Fig. 13. The preamplifier signal-to-noise ratio is 60 db at the 7 kc position while the overall system noise level is 53 db from program level. B+ and filament power for the preamplifier is supplied by an RCA BX1E power supply which may be mounted in the pedestal or in a rack (see Fig. 11). One BX1E power supply will accommodate two TP-6A projector preamplifiers.

The exciter lamp power supply is the RCA 9516. It can also supply two projectors when sound changeover by switching the exciter lamp power is used. Space for mounting this supply is also available in the pedestal.

#### Control System

Accessibility is an important requirement of the control system. The controls of the TP-6A projector have been located

with this requirement in mind. The control knobs and pushbuttons are functionally designed. The mechanical controls for manual turnover, changeover, framing and focus are all operable from both sides of the projector. The focus control arrangement is especially useful when the projector is used in a two projector multiplexer installation. The image from both projectors can be focused by looking directly at the iconoscope mosaic.

Electrical controls are grouped to facilitate operation. The main momentary contact switches are provided with large knobs which lend themselves to easy hand operation.

On the control panel, shown in Fig. 14, just beneath the threading compartment are the main operating controls. The circuit breaker near the center of the panel handles all of the power to the projector. To the right of the circuit breaker and near the top is the "start" pushbutton. Next to it is the "run" pilot lamp and at the extreme right is the "stop" pushbutton. Beneath the "start" switch is the "still" pushbutton. Next to it is the "remote-local" switch with a pilot lamp above it to signify when control has been given to a remote location. In the lower right corner is the "ready" switch which preheats the projection lamp and prepares the projector for operation. The control system used has been designed to operate with the RCA remote control panel. The control functions are handled by two contactors and a control voltage transformer mounted on a panel at the rear of the projector. Both this panel and the front control panel are hinged panels to allow easy access.



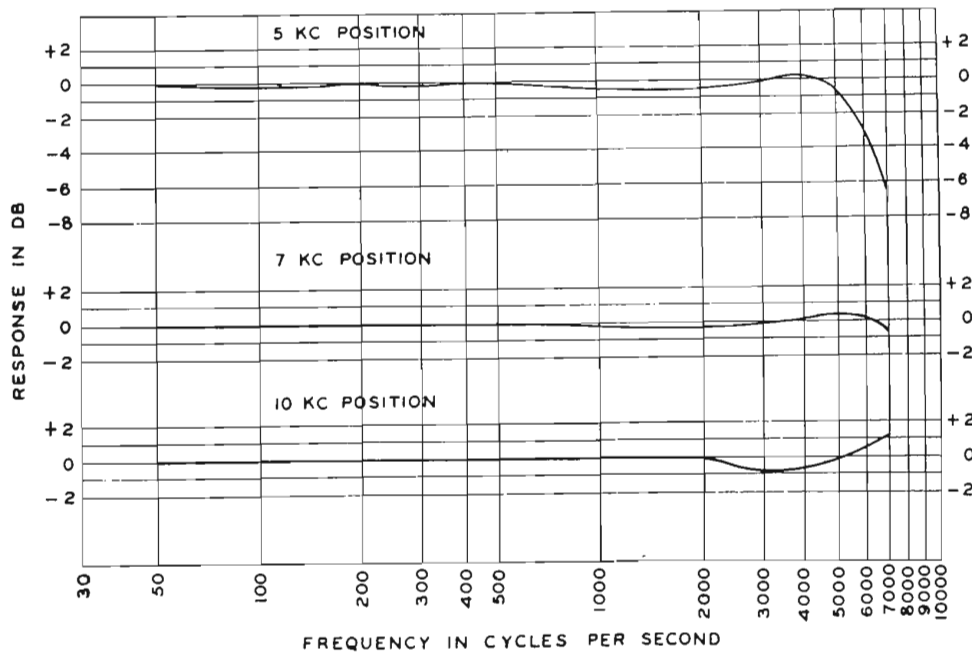

FIG. 13. Overall response curves of a typical TP-6A Projector using "SMPTE" multifrequency test film.

At the left of the main power circuit breaker are the controls for regulating the voltage on the projection lamp filament. A variable transformer is used and a voltmeter is included to enable the projectionist to keep the voltage within the lamp rating. An elapsed time indicator helps the keeping of regular maintenance schedules.

At the extreme left of the control panel is a pilot lamp labeled "lamp failure" with a "reset" pushbutton beneath it. This lamp automatically lights when a lamp change has been made and indicates that a burned out lamp is in the emergency position.

#### Pedestal and Covers

In the design of the pedestal, the rigidity of the machine and the ability to level the projector were two prime considerations. Fig. 11 shows an overall back view with the access panels open.

The leveling adjustments are made between two heavy castings at the base. The lower base casting is secured to the projection room floor. Slots are provided for moving the machine along the optical axis after it is aligned.

In the pedestal, accessible through a snap-on panel, is the take-up drive with its separate motor described previously and space for mounting the two power supplies associated with the equipment.

The projector head covers are castings and are easily removable. One important feature is that the machine can be oper-

ated with the covers removed, allowing easy servicing.

#### Conclusion

The design of the RCA TP-6A projector provides the maximum facility for the

programming requirements of the video broadcaster. Although the operational features and the heavy duty construction are most important, the functional styling deserves special mention. The television broadcaster's increased use of film should help to bring about new advances in the quality of both the picture and sound of 16mm film.

#### Acknowledgment

The successful design and production of the TP-6A projector required the cooperation and interest of many persons. Those closely associated with the project were: J. J. Hoehn and R. N. Lipman of the Commercial Sound Engineering Section, who designed the projector head; C. C. DeWitt of the Broadcast Audio Engineering Section, who designed the preamplifier; S. Pike of the Functional Design Section, who was responsible for the styling. R. D. Houck assisted with the work on the control system. The coordination of the project was the responsibility of the author along with the design of the control unit and pedestal. Credit is given to the Drafting Groups of the Commercial Sound Section and Broadcast Studio Section and to the Engineering Model Shop for their good performance.

FIG. 14. Closeup of TP-6A control panel which is conveniently located for the operator.

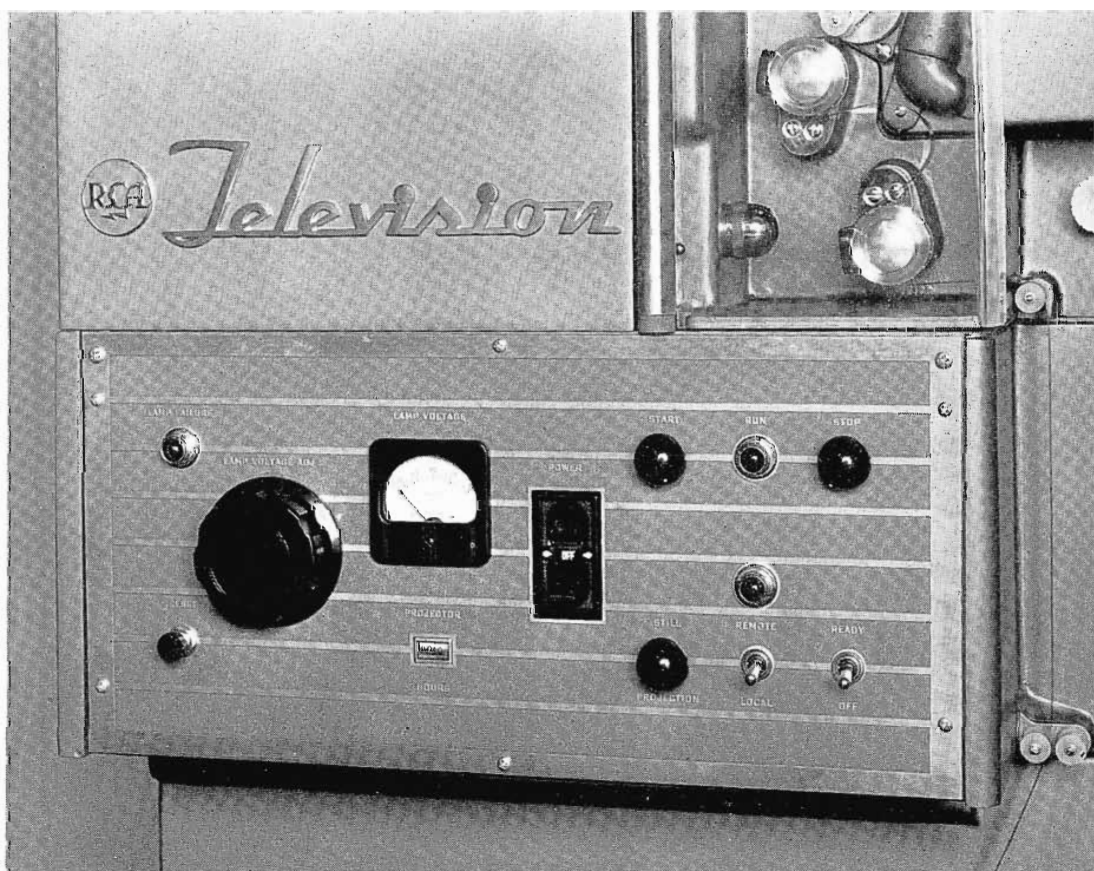

# NEW 50-KW VHF SUPERTURNSTILES

by H. H. WESTCOTT  
Broadcast Engineering Section

The swift expansion of the television field has brought with it the demand for transmitting antennas in large quantity and at reasonable price. They must be capable of being mounted on towers up to fifteen hundred feet in height and provide reliability under drastic extremes of weather. With an absolute minimum of servicing, such antennas must meet and maintain electrical specifications as rigid as those placed on many types of laboratory equipment operating under controlled conditions.

Public demand for stronger signals and for better pictures has dictated the requirement for greater power output by the broadcaster and closer and closer tolerances on the electrical characteristics of the radiated signal. This need for greater radiated power has, in turn, meant increased size of the antennas to obtain higher gain and has necessitated greater power-handling capability of its electrical components.

RCA has met these requirements in the VHF range with the new 50-KW, 6- and 12-section Superturnstiles—powerful, rugged and reliable.

Built to handle 50 kilowatts on any channel, in anticipation of future increases in allowable radiated power, and to withstand the wind-loading of 110\* mile-an-hour gales, these antennas have still maintained the advantages of "easily-handled" components, mass-produced and interchangeable parts, rapid and orderly assembly, and precision electrical characteristics—requiring no special setting or adjustment in the field. All these factors, with the added special features of vertical pattern-shaping to obtain better coverage, controllable beam tilt for difficult locations, and a choice of several methods of tower line feed, combine to make the new RCA Superturnstiles truly great antennas.

A glance at some specific features in their construction will indicate the careful planning and thorough engineering that has gone into the basic design.

\* Actual wind velocity rather than indicated.

FIG. 1. Photo of the new 12-section (50-KW) antenna shown during installation at KTBC-TV, Austin, Texas.

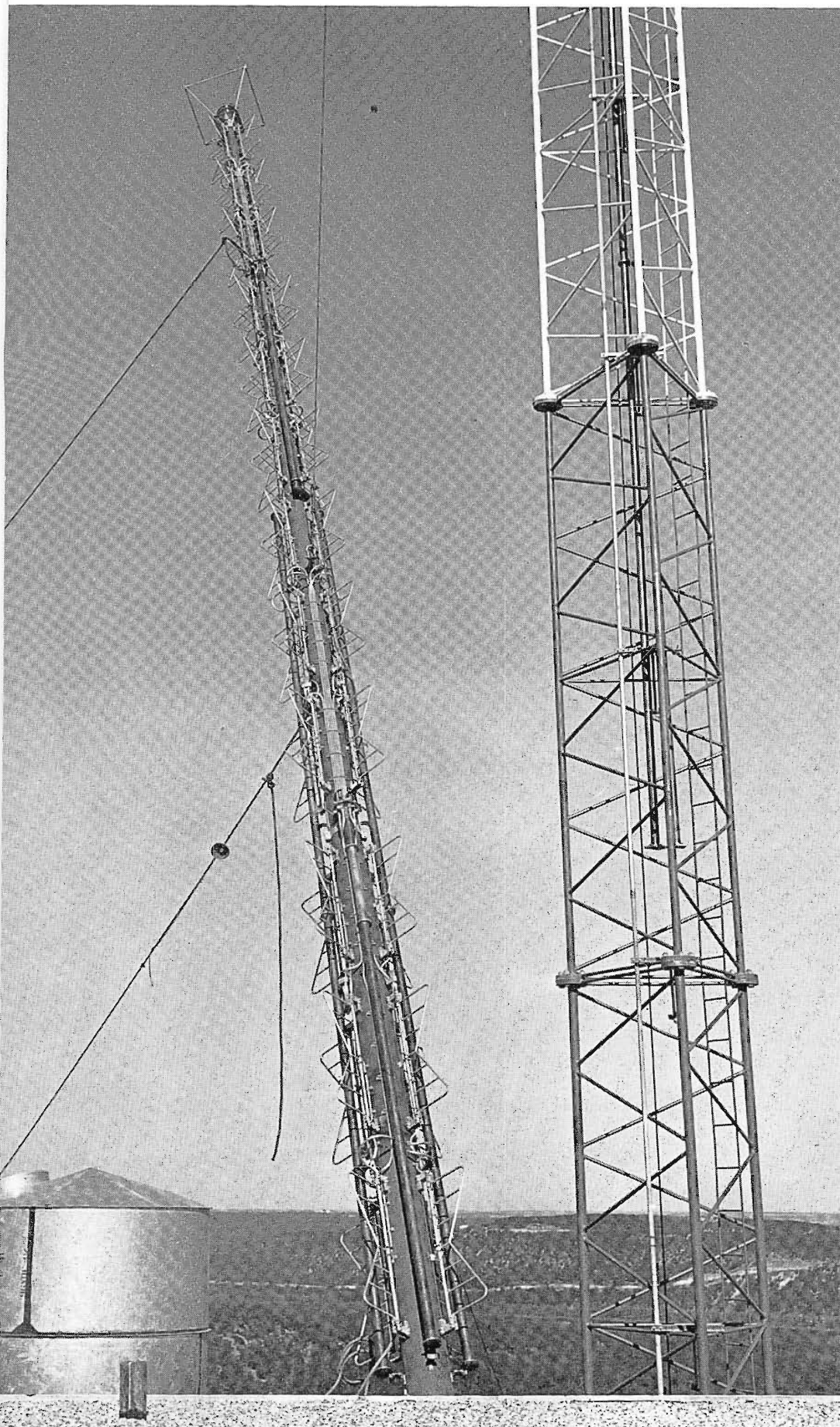

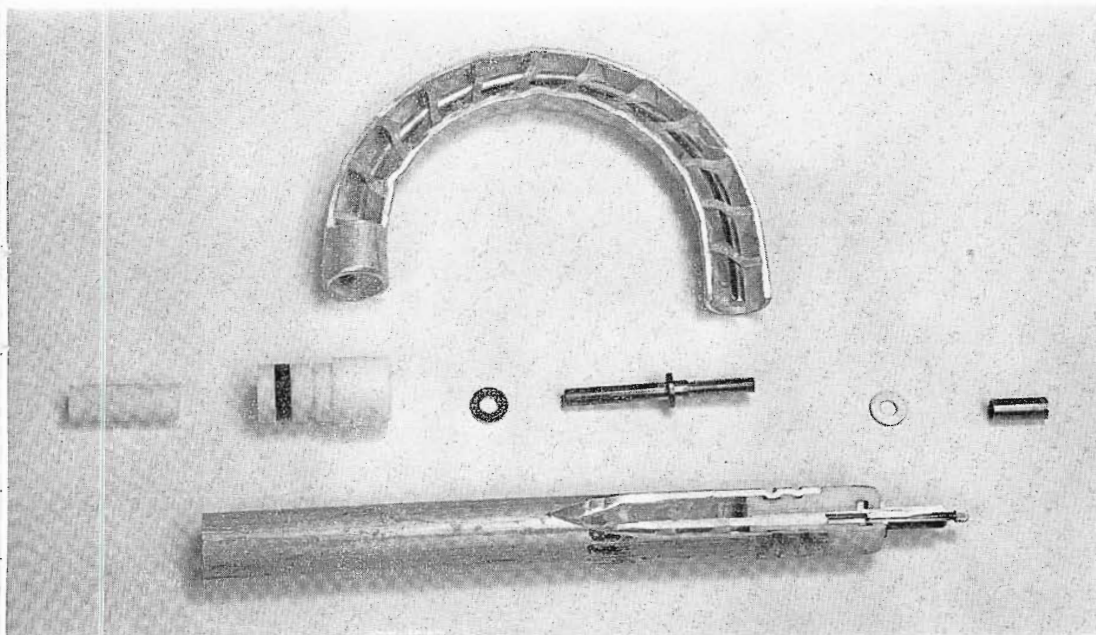

FIG. 2. Exploded view of a section of Styroflex feedline with segments cut out to illustrate construction.

### General Description

The new antennas comprise the following types:

| Type    | Channel | Band   |
|---------|---------|--------|
| TF-6AL  | 2-3     | Low    |
| TF-12AL | 2-3     | Low    |
| TF-6AM  | 4-5-6   | Medium |
| TF-12AM | 4-5-6   | Medium |
| TF-12AH | 7-13    | High   |

These new antennas, of course, supplement the widely accepted 3-, 5-, and 6-section antennas which have already won such favor over the past six years.

The Superturnstile antenna consists of a central sectionalized steel pole upon which are mounted the individual radiators or "bat wings". These radiators are mounted in groups of four around the pole to form a "section" and the sections are stacked one above the other to obtain the desired gain. Fig. 1 illustrates this construction showing the TF-12AH, with 12 sections, being erected at KTBC-TV, Austin, Texas.

On these antennas, each of the radiators is fed separately by its own feedline, to whose impedance that of the radiator is carefully matched. The feedlines, in turn, are combined in sets of twelve at junction boxes which perform the dual function of feeding power simultaneously to all feedlines and of transforming the combined impedance of these lines to that of the 51½ ohm transmission line which carries the power from the base of the antenna. This latter function is achieved by the use of three-stage transformers immediately

below the junction box. At the base of the antenna, the transmission lines are combined by appropriate coaxial networks with the transmission lines carrying power from the transmitter up the supporting tower. This "combining network", as will be seen, makes possible a number of the very desirable features of the RCA Superturnstile.

Let us examine some of the features in detail with special attention to the mechanical and electrical design and the considerations which are involved.

### 50-Kilowatt Power Input

The handling of 50 kilowatts imposes severe requirements on all electrical com-

ponents of an antenna, particularly when such an antenna must be expected to operate under high ambient temperatures and, at times, under extreme conditions of electrical loading. These new Superturnstiles are rated in terms of "TV power", that is, with 50 kilowatts imposed at "peak of sync", average picture power being approximately 60 percent of this value, and sound power being 50 percent of peak of sync picture power. Hence, the CW rating of the antenna is actually 1.1 times 50 or 55 KW. Operating conditions are assumed of transmission for substantial periods at "black level" with ambient temperature of 122° F., and no wind.

Most severely loaded under these conditions are the feedlines which carry the power to the separate radiators. They must not only carry more than one and one-half kilowatts apiece at the higher frequencies but must be flexible enough and small enough to meet the space limitations of the small diameter, radiator-carrying poles.

Styroflex, a coaxial cable developed in Germany and now being manufactured in this country, was chosen to meet the requirements. Although only ¾ inch in diameter, this low-loss, highly flexible cable carries the power with a good margin of safety. Its solid copper inner conductor is supported within the aluminum outer conductor by helically wound narrow ribbons of thin polystyrene tape "one-atop-another". The Styroflex line can be bent by hand to curves of 3-inch radius without changing its electrical characteristics or impairing its mechanical structure.

The teflon end seal, at the radiator end of the feedline, tightly seals the line against the entry of water or the leakage

FIG. 3. A junction box of advanced design is employed in the 12-section antennas. Reflectometer wells enable a constant indication of electrical condition of feedlines.

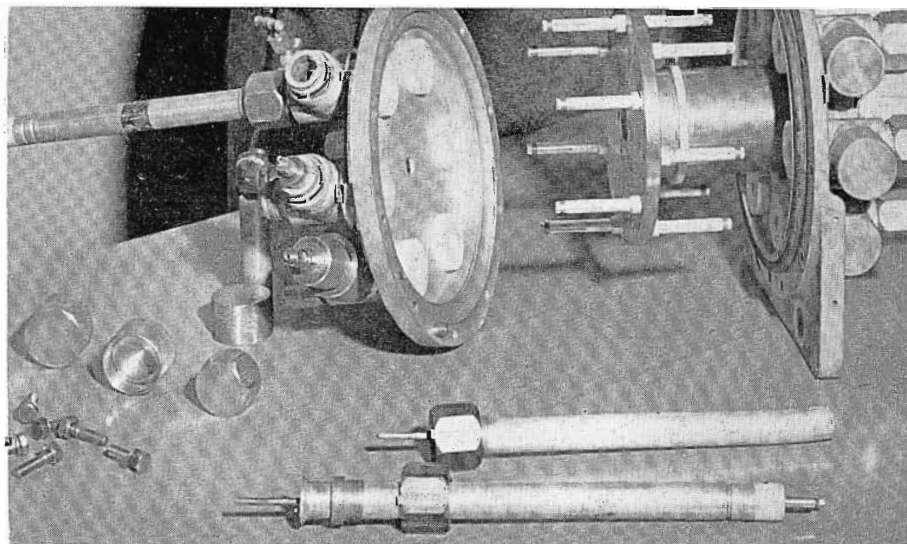

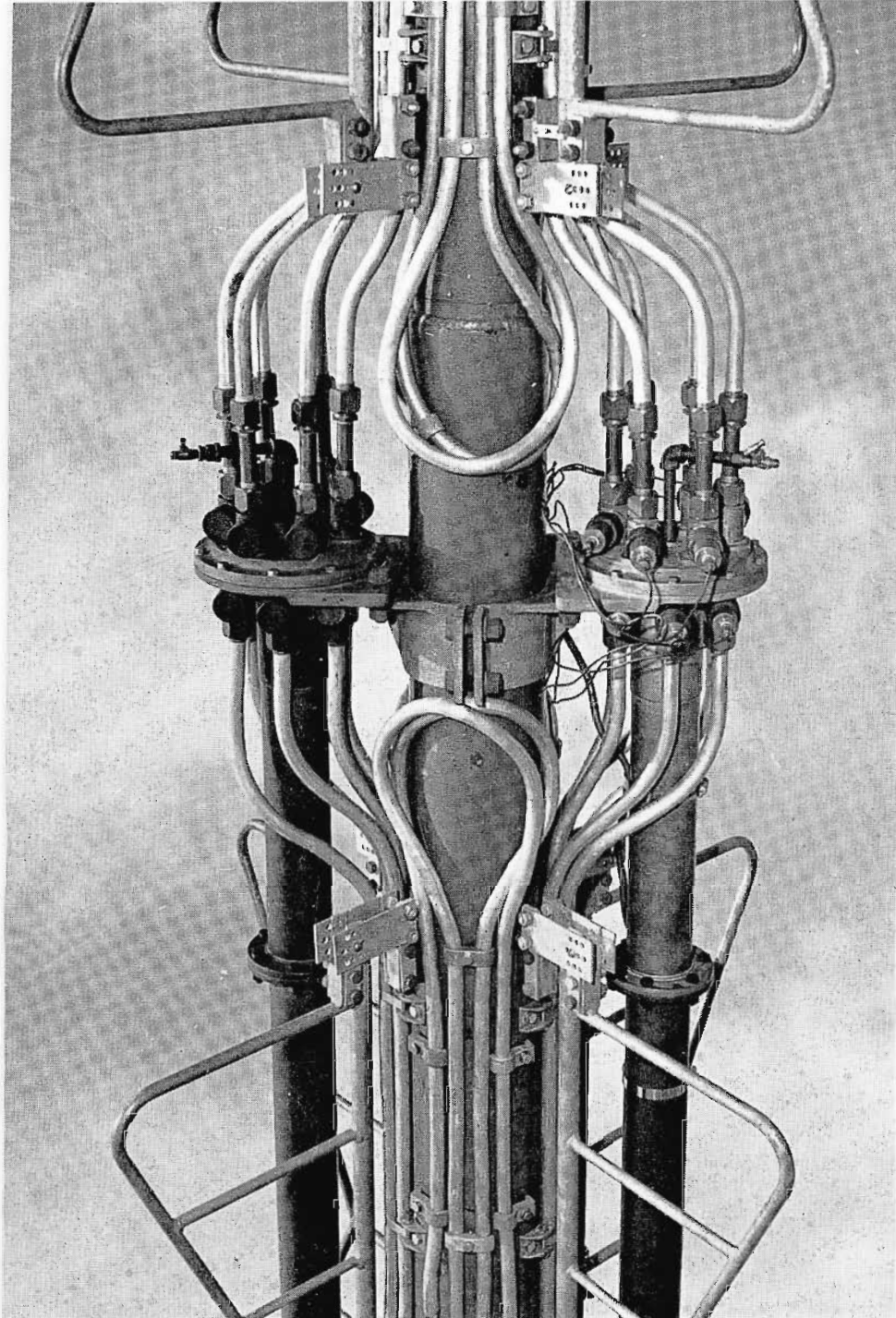

FIG. 4. Closeup view of new junction box as it appears installed on a 12-section antenna (TF-12AH). Test reflectometers are in use in the right hand junction box.

of the dry nitrogen or air with which the line is pressurized. To insure against failure under low temperature conditions (more drastic than those at high temperature), all end seals are pressure tested at  $-40^{\circ}$  F. followed by a similar test at room temperature.

A "bleeder valve" is provided on each end seal to make possible the purging of the feed system with dry air if this should ever become necessary.

Fig. 2 shows portions of a Styroflex feedline and endseal with segments cut out for demonstration purposes.

At the junction box end of the feedlines are special flare fittings by which a water-tight and air-tight connection is made to

the junction box. The method of connection of the inner conductor at this point is specially designed to permit the slight axial movements of the inner conductor which result from changes of temperature when power is applied to the antenna and to allow for normal variations within manufacturing tolerances of the relative lengths of inner and outer conductors.

The design of the junction boxes and the junction box transformers and the materials used in their construction are such as to reduce to a minimum the heating incidental to the transmission of high power.

Great care has been taken in the development of these antennas to avoid the

loading of the feedlines beyond their rated capacity. In order to constantly monitor the conditions within the lines (during the development work), specially designed reflectometers were evolved which, upon insertion into a line, would give at all times an indication of the standing wave ratio in the line. This, in turn, is an indication of the degree of impedance match of the radiator to the line. Reflectometer "wells" or "heads" are incorporated into the junction box structure at the point of connection with the feedlines and into these are slipped the reflectometer "pellets", containing the necessary bridge circuit and probe. Fig. 3 shows the construction as well as the internal elements of the junction box.

Employment of these reflectometers is illustrated in Fig. 4.

While, at this time, the reflectometers are used only for developmental work (see Fig. 5), the junction boxes of all standard antennas of this type are equipped with the wells. These wells are sealed by appropriate caps at the time of shipment. RCA plans call for the development, in the near future, of reflectometers of a type appropriate to field use. By means of these, the broadcaster may determine at any time the electrical condition in any one of the feedlines, even though the antenna is mounted on its supporting tower many hundreds of feet away.

Special care has been taken to eliminate resonant circuits on the exterior of feedlines and transmission lines which could lead to overheating and to arcing.

#### Impedance Matching and Bandwidth

The overall input impedance of the Superturnstile is 51.5 ohms. Special transformers are available, if desired, for matching the antenna to transmission lines of other values of surge impedance.

Throughout the developmental work, special precautions were taken to insure that the impedances obtained were those of the antenna in free space, that is, unaffected by the proximity of ground. Prototype antennas were developed on 12-foot high supporting frameworks above space cloth frames which duplicated electrically the condition of free space. Fig. 6 shows the space cloth framework below the pilot model of the TF-6AL. Further tests made with the antennas in a vertical position provided double assurance that those tests made horizontally were correct (see Fig. 7).

The impedances of the separate radiators are matched closely to that of the individual feedlines to reduce to a min-

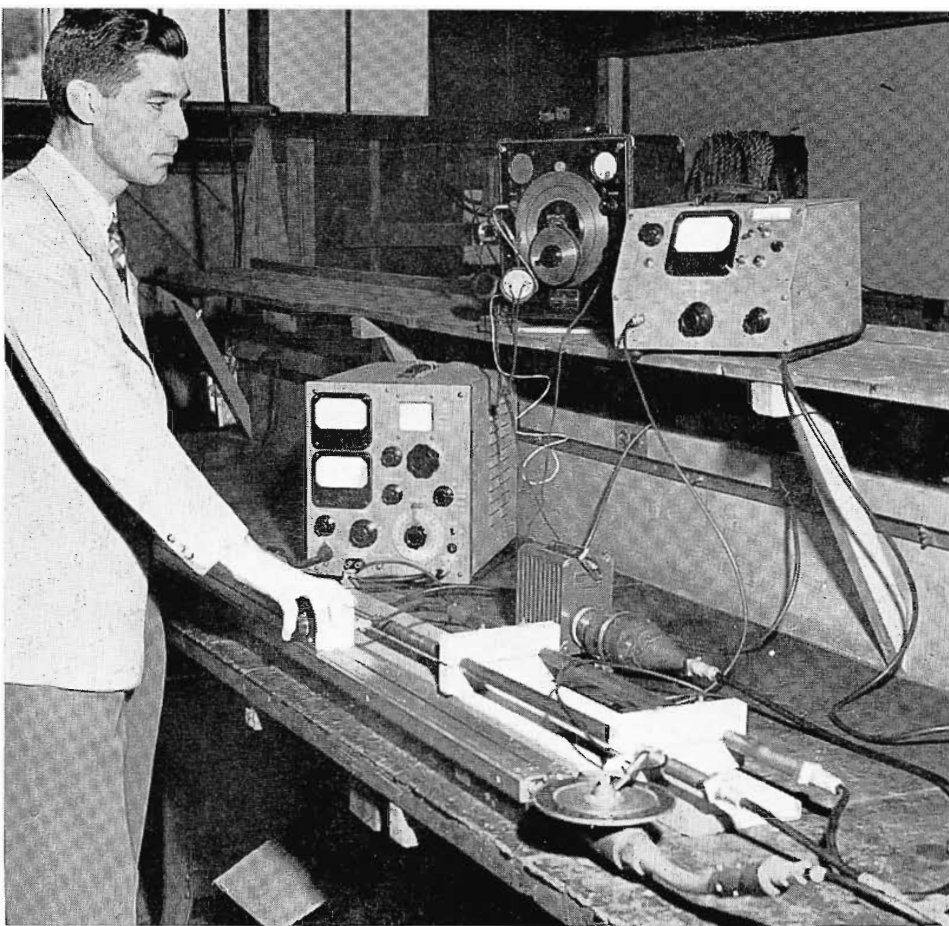

FIG. 5. Laboratory tests being conducted during development of the new feedlines and junction box.

imum the heating due to standing wave ratios and to provide the best overall impedance match at the base of the antenna.

To insure against variations in electrical characteristics due to mechanical variations normal to manufacturing tolerances, particular care was given to holding the characteristics well within specifications.

All items which control these characteristics are manufactured to precision dimension and are closely factory checked before shipment.

Only such items as are required for the particular channel involved are shipped with the antenna so that no field selection or adjustment is required.

#### Pattern and Gain:

The Superturnstile is an omnidirectional antenna. That is, in the horizontal plane, nearly equal energy is radiated in all directions.

More precise methods of pattern measurement and gain determination were used in the development of these antennas than have ever before been employed for antennas of similar size. The carefully chosen test site was cleared, where necessary, to reduce reflections and a thorough study was made of the condition of the electrical field in the immediate vicinity of the units under test to make certain that any non-uniform conditions were accounted for.

To insure that the proximity of ground did not jeopardize the circular characteristics of the antennas radiating patterns during test, the antennas were placed in a horizontal position on 25-foot high supports where they were rotated about their axes (see Fig. 8). The result of these tests indicate that the horizontal pattern does not vary from a true circle by more than  $\pm 2$  DB at any point.

In order to determine the vertical patterns, the antennas were placed on a 12-foot high rotating mount as shown in Fig. 9, and rotated horizontally about their electrical centers. Due account was taken of the presence of vertical components of

FIG. 6. Pilot model of the Type TF-6AL Superturnstile Antenna during field tests. Note space cloth framework below the antenna.

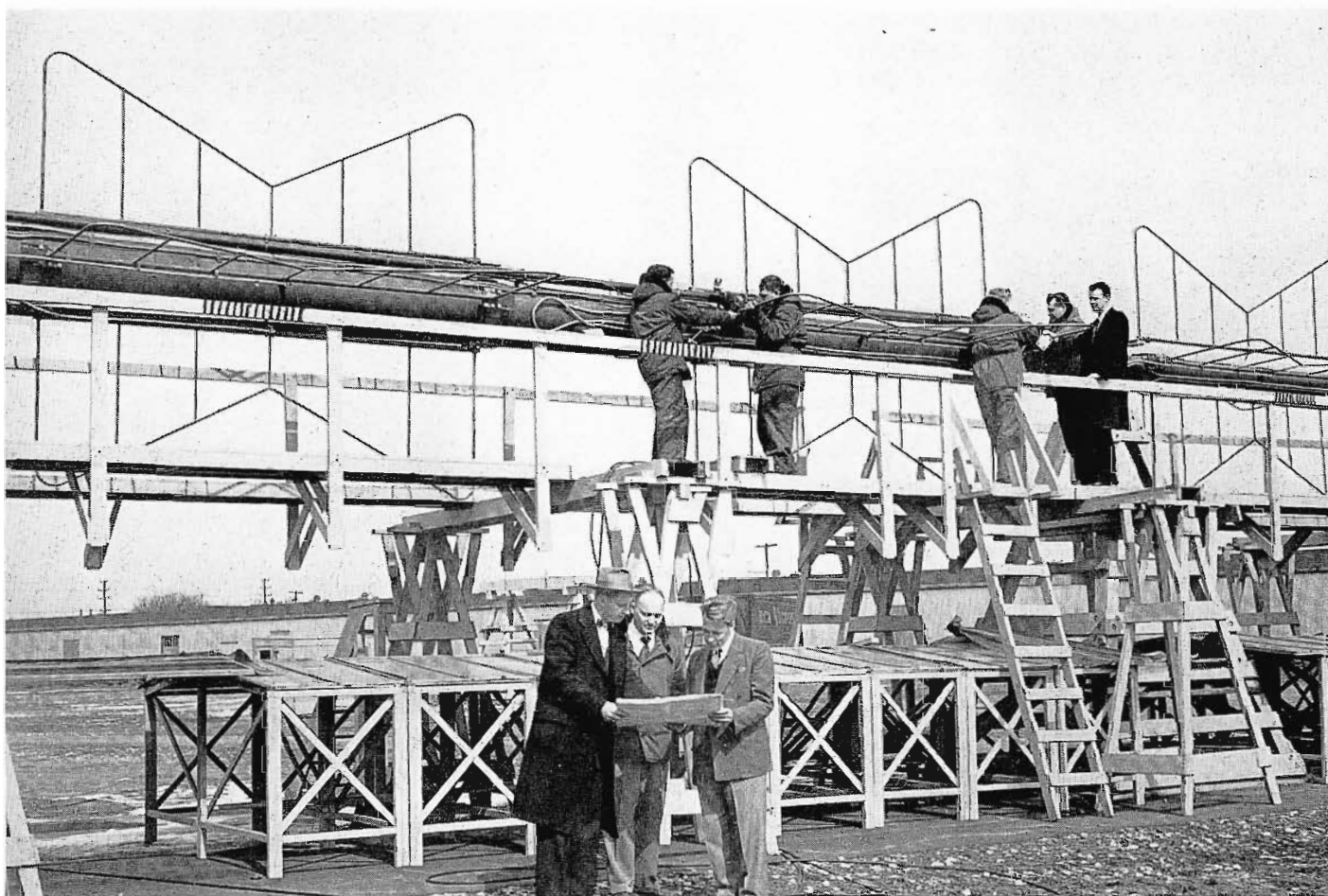

power which normally would represent lost energy since receiving antennas are horizontally polarized.

The vertical and horizontal patterns so obtained were used in the determination of the actual power gains of the antennas.

### Flexibility

One of the most outstanding of the Superturnstile features is its versatility. With the transmission lines from the separate junction boxes leading directly to the base of the antenna instead of combining on the antenna structure, it is possible to feed 12-section antennas with one, two, or four tower lines and 6-section antennas with one or two. At the same time, a number of methods of emergency operation are made possible. For illustrations of the methods of feeding the new 12-section antennas, refer to BROADCAST NEWS No. 71, pages 38 through 43.

Type "A" Feed is the standard feed system of the 12-section antennas. Bridge-diplexing combines visual and aural operation into the antenna. If one line fails, it is replaced at the diplexer by an R-F load and wattmeter for temporary operation. A "figure 8" radiation pattern results, giving a large proportion of the coverage obtained under normal operation.

Type "B" Feed resembles Type "A" except that the combining network may be placed in the transmitting station. This makes possible additional methods of emergency operation, such as the operation of any two of the four portions of the antenna, by the use of appropriate coaxial switches. Either "figure-8" or full radiation patterns may thus be achieved.

Type "C" can be used when the transmission line length is very great and where other emergency antenna facilities are available. A notch diplexer is required.

Type "D" makes possible a circular pattern for emergency operation, using a notch diplexer.

Two methods of feeding the 6-section antennas, corresponding to Types "B" and "C" for the 12-section models are also illustrated in BROADCAST NEWS No. 71, page 43.

In addition to a choice of methods of feed and provision for emergency operation, the combining network incorporates two other outstanding features—unequal power division to achieve more uniform coverage and beam tilt for special requirements.

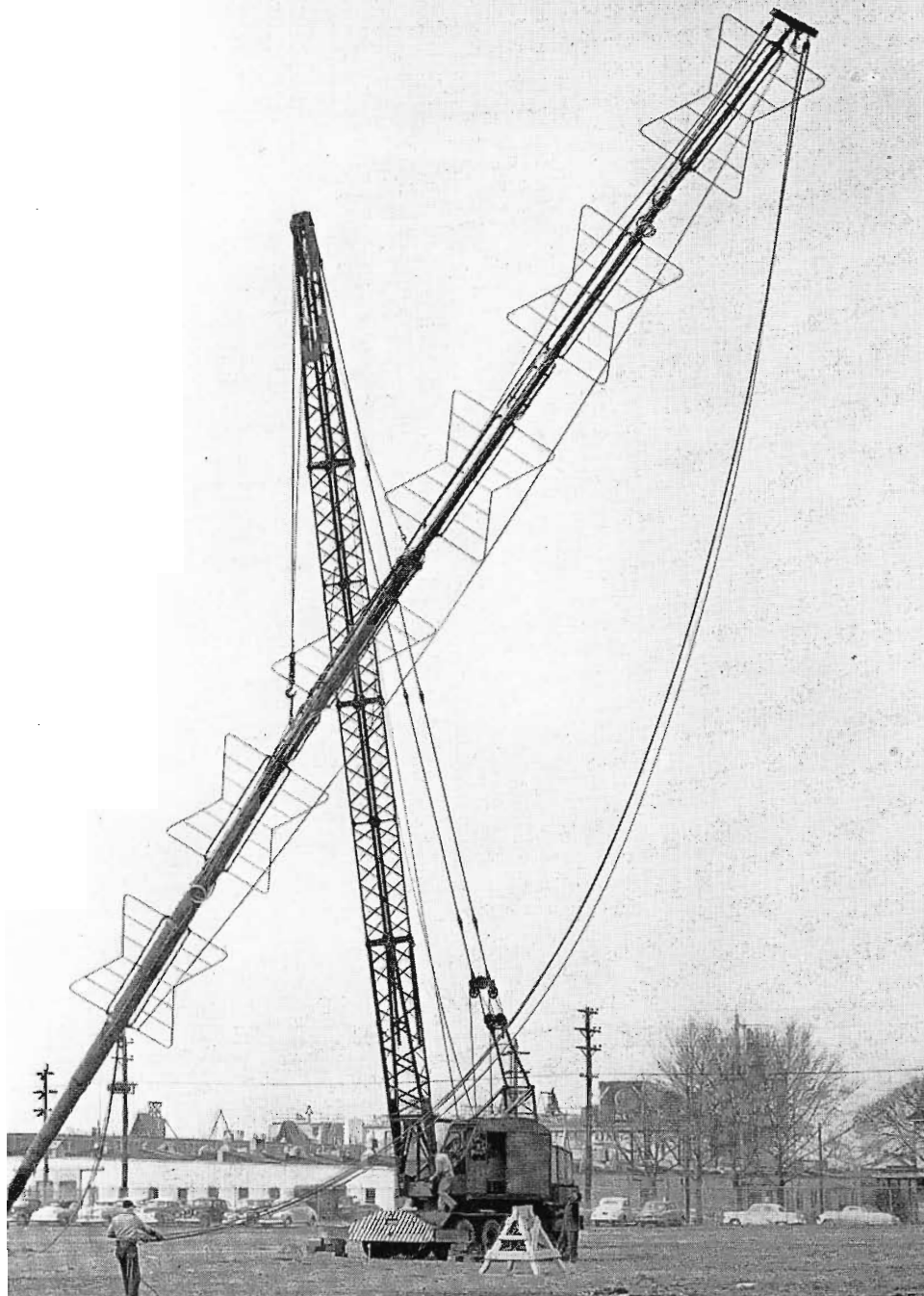

FIG. 7. The TF-6AL Superturnstile being raised to vertical position so that a "double check" can be made of the measurements obtained when horizontally positioned.

At the point at which the tower lines branch to feed the upper and lower junction boxes, special power-dividing transformers direct unequal amounts of power to the upper and lower halves of the 12-section antennas. The result is a "filling-in" or increasing of the signal strength in the minima of the radiation pattern—the angles at which the signal strength is weakest. In the standard 12-section Superturnstiles, 70 percent of the power is directed into the upper half and 30 percent into the lower. Other ratios may be achieved for special conditions by a simple substitution of power-dividing transformers.

In locations where it is desired that the main beam of radiation be directed below the horizon, such as near large bodies of water, a simple extension of the network

lines leading to the lower half of the antenna provides a phase delay which electrically tips the beam. "Phasing sections" of this type to obtain any desired amount of tilt are available.

The Superturnstile is as versatile mechanically as it is electrically. Normally tower mounted, with a section of the pole buried in the tower structure for added strength, the TF-6AM and the TF-12AH may be pedestal-mounted where conditions of the supporting structure make it desirable.

The Superturnstile may also be employed in a variety of combinations with AM antennas, FM Pylons, VHF Super-gain antennas, UHF Pylons and even with other Superturnstiles. An example might be the lower half of the TF-12AM Su-

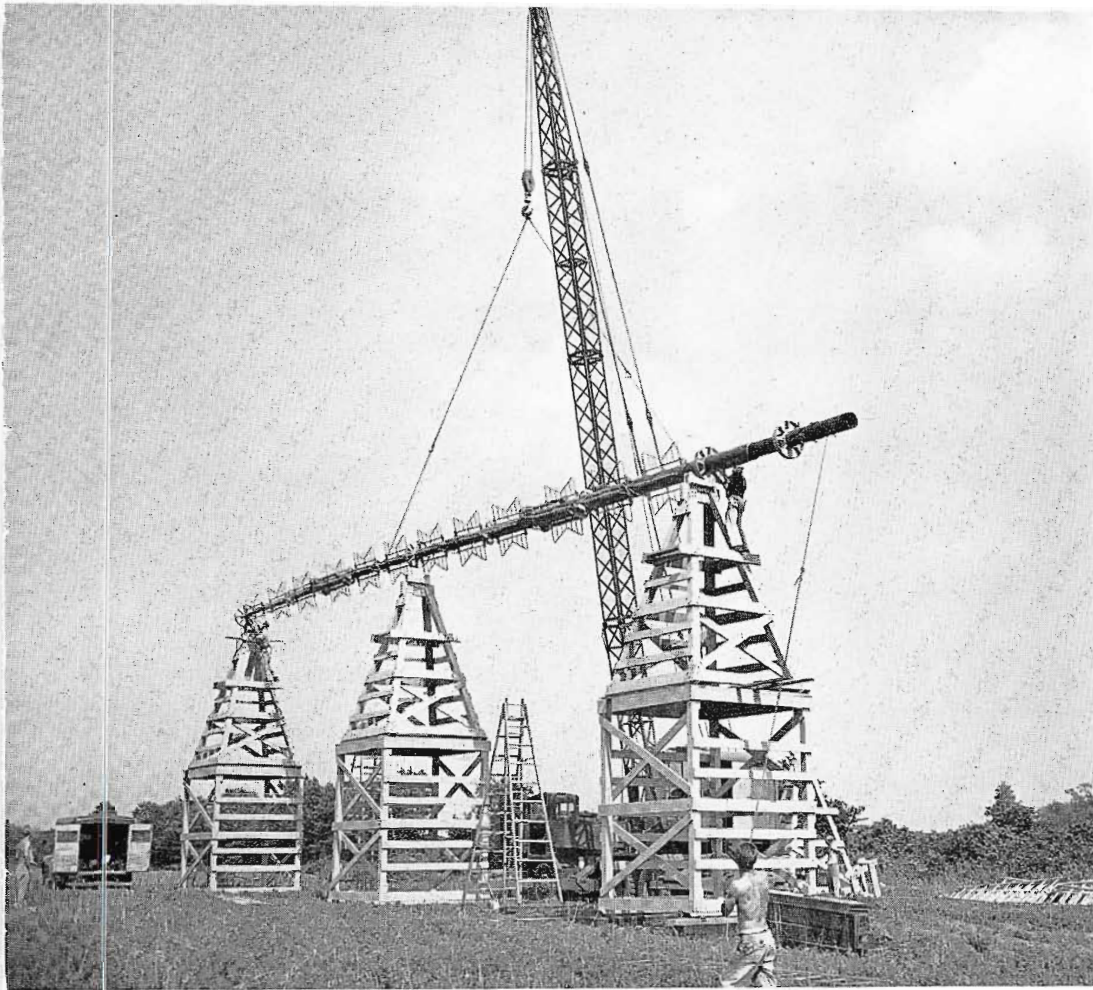

FIG. 8. Antennas were placed on 25-foot high supports and then rotated to insure that radiating patterns are not affected by proximity of ground.

perturnstile, mounted on a multi-section Supergain and supporting an RCA UHF antenna.

### Ruggedness and Reliability

Supported on poles designed by one of the foremost firms of structural consultants in the United States to withstand the buffeting of 110 mile-an-hour winds with a 3-to-1 safety factor, the antennas are specifically designed to meet drastic weather and climatic conditions.

All components are built to stand the stresses involved in the high pressures (50 pounds per square foot on flat surfaces)

existing under the specified wind velocity, and the changes due to temperature variations from summer heat to winter cold. Provision is made for the flexing of components due to normal bending of the pole, as typified by the leaf-spring transmission line supports.

All steel parts (except the pole which is protected by two coats of paint before installation and a third after mounting) are hot-dip galvanized for long life.

High strength hardware and a maximum use of non-ferrous parts insure continued strength and serviceability. From its new lightning protector, specifically designed to

protect the Superturnstile with its many projecting radiators, to the disc-protected beacon lighting cable running up the interior of the pole, ruggedness and reliability are keynotes of the design.

### Assembly and Erection

With an eye to the problems of transportation and erection, the weight and sizes of pole sections have been limited to those transportable in standard common carriers and to values agreed upon by consensus of construction organizations as being readily handled during installation.

The TF-6AM, 6AL, and 12AH can be lifted efficiently in one piece, completely dressed, while the larger TF-12AM and TF-12AL are usually assembled and field-welded at the tower top. In either case, the antennas are normally assembled completely and electrically tested on the ground under the supervision of trained RCA Service Company personnel. Adequate time for this service is provided for in the regular price of the antenna.

To aid the erection, lifting lugs are placed at advantageous points on the pole sections. "Bottoming" rings and set-screw adjustment insure straightness of the pole upon welding.

Components of the feed system are designed for simple and trouble-free application, and properly dressed, any feedline or transmission line may be removed without mechanically affecting the other parts of the system.

Complete parts lists, instruction books, and assembly drawings accompany each antenna.

All antennas can be easily transported, assembled, and installed with maximum effectiveness in a minimum of time.



FIG. 9. In this view antenna was placed on a 12-foot high rotating mount and rotated about the electrical center during vertical pattern test.

# SEE YOUR NEAREST RCA BROADCAST

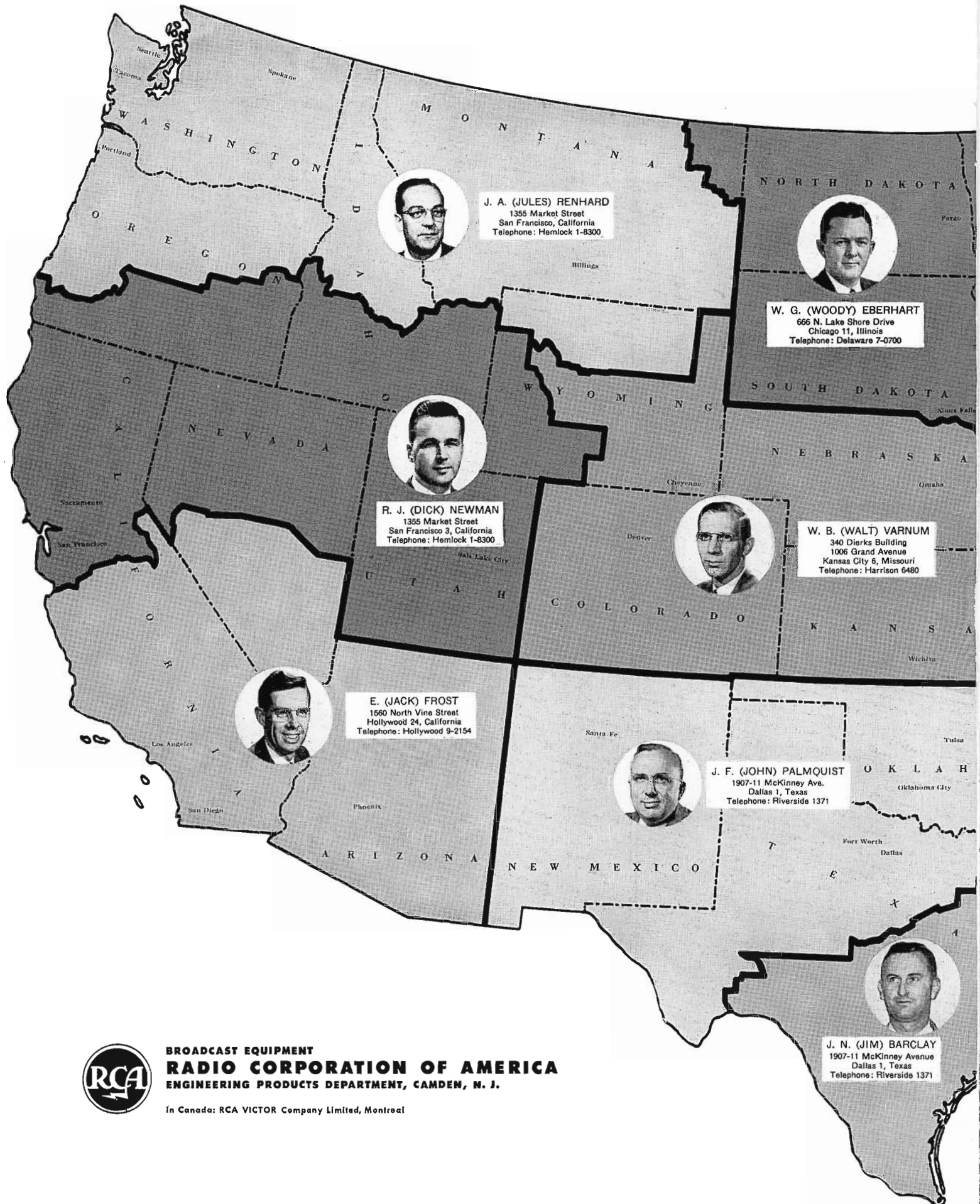

**J. A. (JULES) RENHARD**  
1355 Market Street  
San Francisco, California  
Telephone: Hemlock 1-8300



**W. G. (WOODY) EBERHART**  
666 N. Lake Shore Drive  
Chicago 11, Illinois  
Telephone: Delaware 7-0700



**R. J. (DICK) NEWMAN**  
1355 Market Street  
San Francisco 3, California  
Telephone: Hemlock 1-8300



**W. B. (WALT) VARNUM**  
340 Dierks Building  
1006 Grand Avenue  
Kansas City 5, Missouri  
Telephone: Harrison 6480



**E. (JACK) FROST**  
1560 North Vine Street  
Hollywood 24, California  
Telephone: Hollywood 9-2154



**J. F. (JOHN) PALMQUIST**  
1907-11 McKinney Ave.  
Dallas 1, Texas  
Telephone: Riverside 1371



**J. N. (JIM) BARCLAY**  
1907-11 McKinney Avenue  
Dallas 1, Texas  
Telephone: Riverside 1371



**BROADCAST EQUIPMENT**  
**RADIO CORPORATION OF AMERICA**  
**ENGINEERING PRODUCTS DEPARTMENT, CAMDEN, N. J.**

In Canada: RCA VICTOR Company Limited, Montreal



# REPRESENTATIVE FOR EQUIPMENT PLANS

**J. H. (JIM) KEACHIE**  
718 Keith Building  
Cleveland 15, Ohio  
Telephone: Cherry 1-3450

**J. R. (JOE) SIMS**  
35 West 49th Street  
New York 20, New Ybrk  
Telephone: Circle 6-4030

**R. S. (BOB) EMCH**  
718 Keith Building  
Cleveland 15, Ohio  
Telephone: Cherry 1-3450

**D. S. (DAVE) NEWBORG**  
718 Keith Building  
Cleveland 15, Ohio  
Telephone: Cherry 1-3450

**J. L. (JESS) NICKELS**  
666 N. Lake Shore Drive  
Chicago 11, Illinois  
Telephone: Delaware 7-0700

**J. E. (ED) HILL**  
John Hancock Building  
200 Berkeley Street  
Boston 16, Mass.  
Telephone: Hubbard 2-1700

**A. (AL) JOSEPHSEN**  
36 W. 49th Street  
New York 20, New York  
Telephone: Circle 6-4030

**E. S. (ED) CLAMMER**  
Front and Cooper Streets  
Camden, N. J.  
Telephone: Woodlawn 3-8000

**J. F. (FRANK) INGELS**  
340 Dierks Building  
1006 Grand Ave.  
Kansas City 6, Missouri  
Telephone: Harrison 6480

**A. M. (ADRON) MILLER**  
666 N. Lake Shore Drive  
Chicago 11, Illinois  
Telephone: Delaware 7-0700

**D. (DAVE) BAIN**  
1625 "K" Street, N. W.  
Washington, D. C.  
Telephone: District 7-1260

**W. D. (WILEY) WENGER**  
1907-11 McKinney Avenue  
Dallas 1, Texas  
Telephone: Riverside 1371

**P. G. (PG) WALTERS**  
522-533 Forsyth Building  
Atlanta 3, Georgia  
Telephone: Walnut 5948

**P. (PAUL) BERGQUIST**  
1625 "K" Street, N. W.  
Washington, D. C.  
Telephone: District 7-1260

**J. W. (JOHN) HILLEGAS**  
522-533 Foreyth Building  
Atlanta 3, Ga.  
Telephone: Walnut 5948

**J. M. (JOE) WALTERS**  
522-533 Forsyth Building  
Atlanta 3, Georgia  
Telephone: Walnut 5948

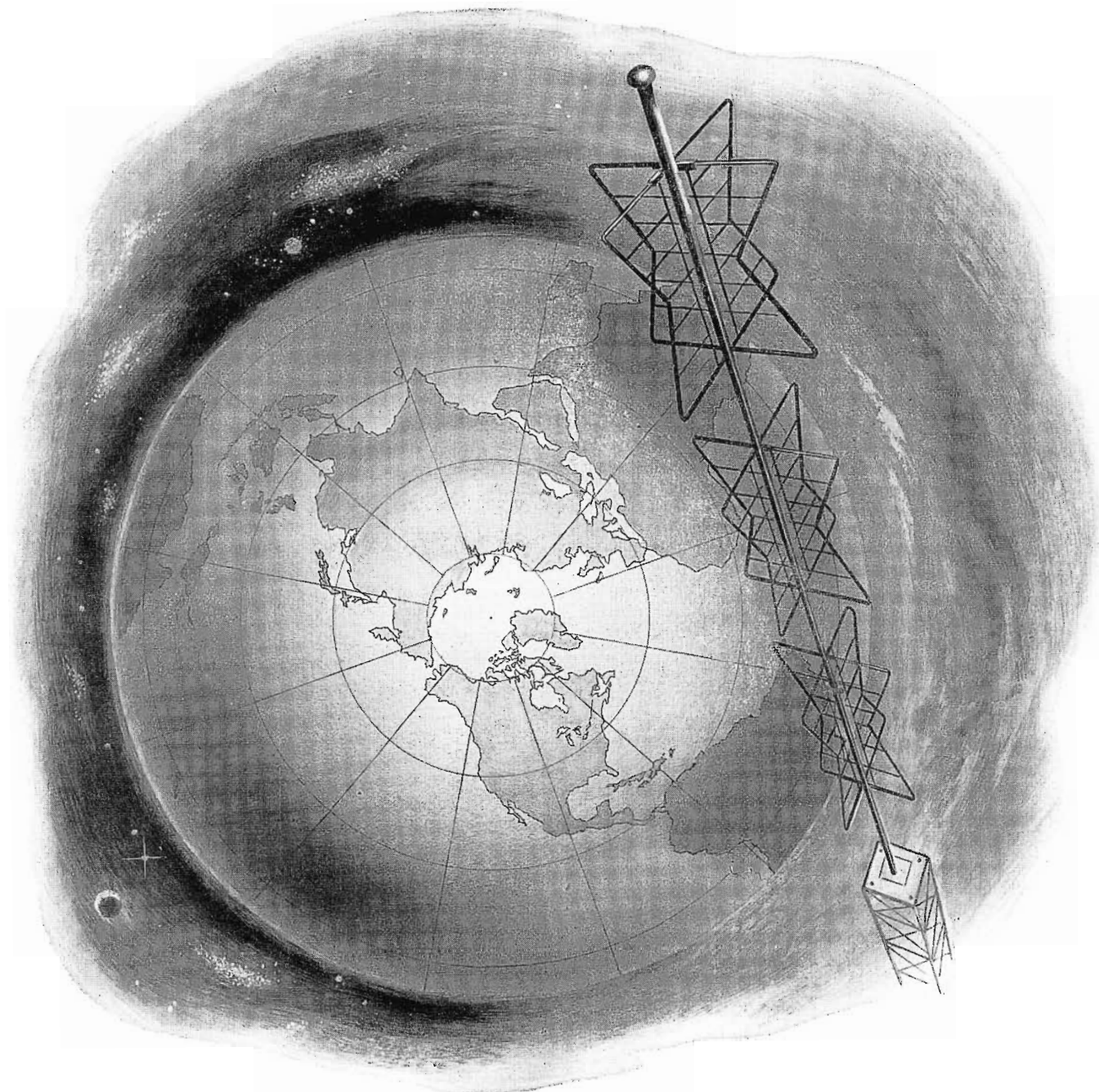

## RCA Television Systems *now serve the world!*

TELEVISION TOWERS are rising round the world. They are symbols of a new era in education and understanding. Increasing numbers of RCA equipped TV stations are on the air or planned for early operation in Brazil, Canada, Cuba, Dominican Republic, Italy, Japan, Mexico, The Philippines and Venezuela.

More and more countries plan for video, the great new teacher. A world

network of TV stations emerges, tapping the reservoirs of culture, improving markets, creating better understanding.

Abroad, as in the U.S.A., RCA has everything for television . . . from camera tube to antenna, from transmitter to receiver . . . and the service of distributors and companies long versed in the electronic needs of their countries.

Only RCA manufactures everything

. . . from TV cameras, through studio and remote facilities which send clear, steady pictures out over the air from RCA transmitters, to the bright, sharp pictures and sound in homes, schools and many other locations.

\* \* \*

Your RCA Distributor or company will be glad to offer information on RCA Television; or write to RCA International Division for the booklet, "World Experience" . . . a stimulating review of TV around the world today.

World Leader in Radio  
First in Recorded Music  
First in Television



RCA INTERNATIONAL DIVISION

**RADIO CORPORATION of AMERICA**

RCA BUILDING

30 ROCKEFELLER PLAZA, NEW YORK, N.Y., U.S.A.



## The tube with the "built-in cash register"



If you operate a 50-kw AM transmitter using high-level modulation . . . if you still use older-type, pure-tungsten filament tubes . . . then this high-power triode can literally save you thousands.

**Take tube cost per hour, for instance:** In a number of 50-kw "AM's", RCA-5671's are still operating after serving over 30,000 hours. Here, as a result of the longer life of the RCA-5671,

actual tube cost runs about 4 cents an hour per tube!

**Take filament-power cost, for instance:** The thoriated-tungsten filament of the RCA-5671 takes 60% less power than pure-tungsten filaments of comparable older tube types—can save you \$1300 or more a year. Take advantage of these major savings. For details, write RCA, Section PI37, Harrison, N. J.

**For tube service in a hurry, call your local RCA Tube Distributor.**



**RADIO CORPORATION of AMERICA**

**ELECTRON TUBES**

**HARRISON, N. J.**

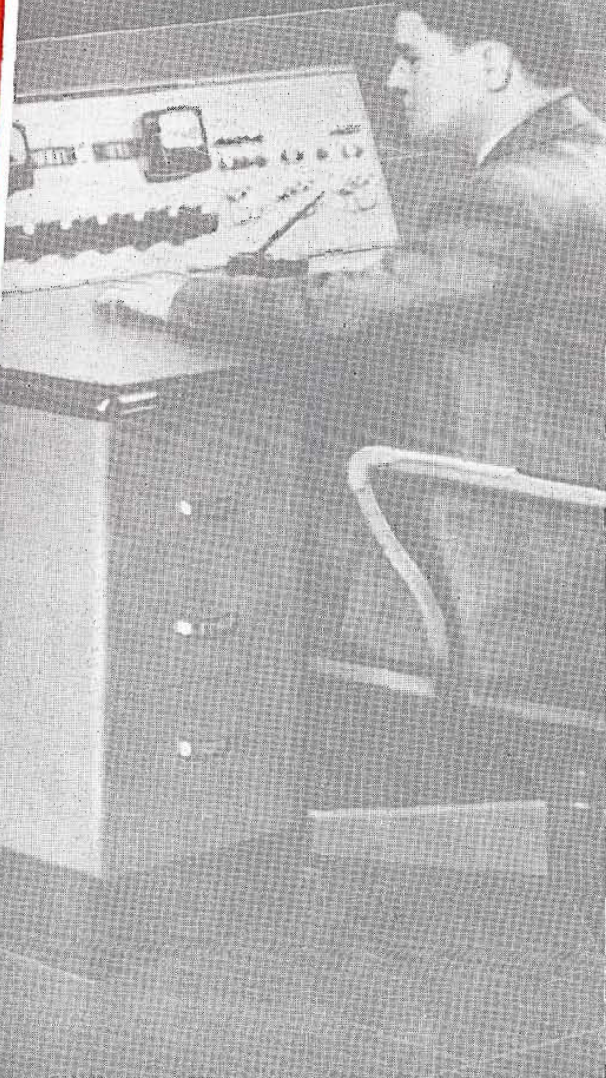

## RCA ANNOUNCES

# A new advanced film-camera for television...

THIS NEW FILM CAMERA does for TV film presentations what RCA's new TK-11A studio camera is doing for "live" pick-ups. The TK-20D camera pro-

vides a remarkable advancement in picture quality and operating convenience over former types—puts "live" quality into films regardless of scene content or shading. Low picture noise level compares with the low noise level of "live" pick-ups.

Operated in conjunction with an RCA TP-9B Film Multiplexer, one TK-20D Film Camera provides show continuity with any one of the following set-ups: (1) two RCA TP-16D 16mm Film Projectors, (2) two RCA

TP-6A Professional Film Projectors, (3) two RCA 35mm Film Projectors, (4) one 16mm and one 35mm Film Projector, (5) or one projector of either type and a slide projector.

With TV programming emphasis more and more on films, let us help you get the most from film—with the new TK-20D. Your RCA Broadcast Sales Representative is ready to help you plan the right film system for your station—with everything matched for best results!

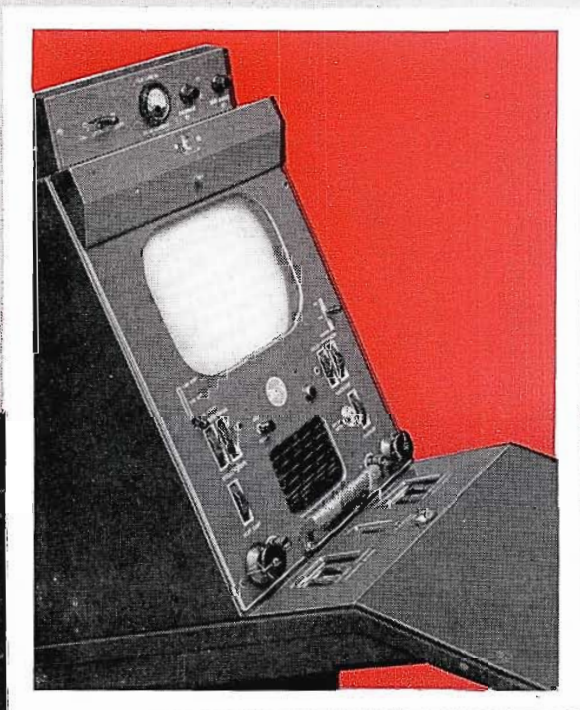

← Iconoscope beam current control, with indicator. A new arrangement that takes the guesswork out of day-to-day adjustments—provides a standard of comparison to help the operator adjust for optimum picture quality. The panel mounts on the housing of the film camera console, or in the remote control console.

# ...Type TK-20D

● "Live" quality all the time—regardless of scene content, shading, or other adjustments. New back-lighting system, and new automatic black-level control permits the TK-20A virtually to run itself!

● "Noise-free" pictures comparable to "live" shows. New high-gain cascode preamplifier, with "noise-immune" circuits, offers 200-to-1 improvement in microphonics. No high-frequency overshoot (trailing white lines). No low-frequency trailing (smear).

● Good-bye edge flare. New edge-lighting system provides substantial reduction in stray light, improves storage characteristic, stops light beam reflections on Iconoscope mosaic. Adjustable light level is provided.

● No more a-c power line "glitches" (horizontal-bar interference)—because camera filaments are operated from a separate d-c source.

● Faithful, high-quality pictures every day—through new beam-current control circuit. No more need to "ride" the shading.



**RADIO CORPORATION of AMERICA**  
ENGINEERING PRODUCTS DEPARTMENT  
CAMDEN, N. J.

# The one and only...

**Type TT-10AL/AH...and an  
will deliver 100 kw (ERP)**

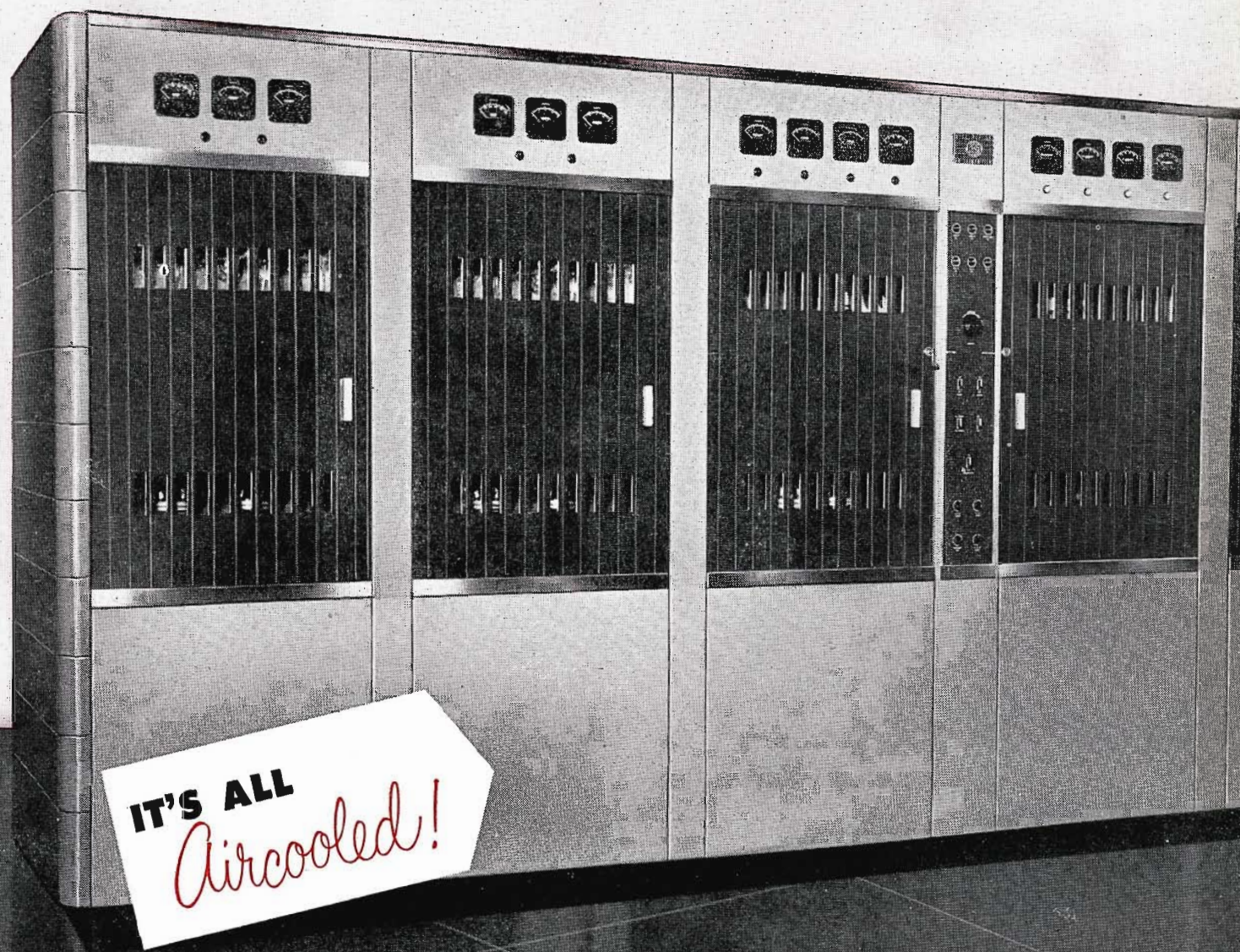

# 10-kw TV transmitter

for VHF

## RCA high-gain antenna... at the lowest cost per kilowatt

• This remarkable new 10-kw TV transmitter, and an RCA high-gain antenna (type TF-12AM), will provide up to 100 kilowatts of effective radiated power. More than twice the

power of any commercial TV transmitter operating today—and AT SUBSTANTIALLY LOWER COST PER RADIATED KILOWATT than other transmitter-antenna combinations!

Using an improved type of air-cooled tetrode in the final power amplifier stages, this transmitter removes all former restrictions on interior cooling and floor-space requirements. No water supplies to bother about. No problem setting up the transmitter in tight quarters (it takes approximately half the floor area of previous

5-kilowatt models and weighs substantially less).

The new RCA 10-kw transmitter is available in two types. Type TT-10AL covers channels 2 to 6. Type TT-10AH covers channels 7 to 13.

For complete information on this new 10-kw... call in your RCA Broadcast Specialist. He can show you what you'll need to get "on the air"—with the power you want—at lowest possible cost. Phone him. Or write Dept. S-E18, RCA Engineering Products, Camden, New Jersey.

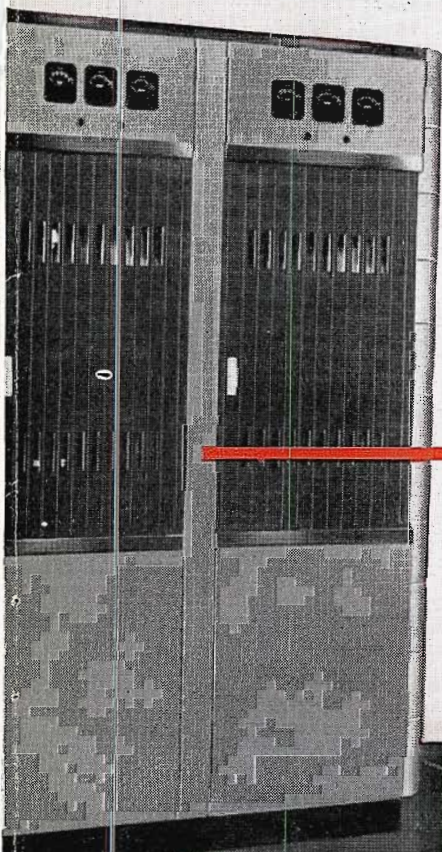

### The Key to High Power and Low Cost

Improved RCA Air-Cooled tetrode—used in the aural and visual finals. Proved for long life, easy to handle.

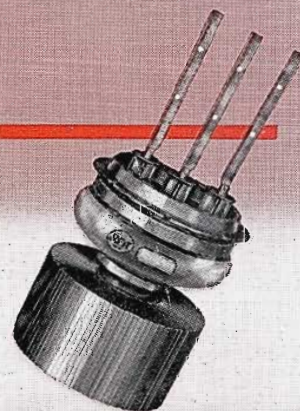

**RADIO CORPORATION of AMERICA**  
ENGINEERING PRODUCTS DEPARTMENT

CAMDEN, N.J.

# SOUND TRANSLATION.

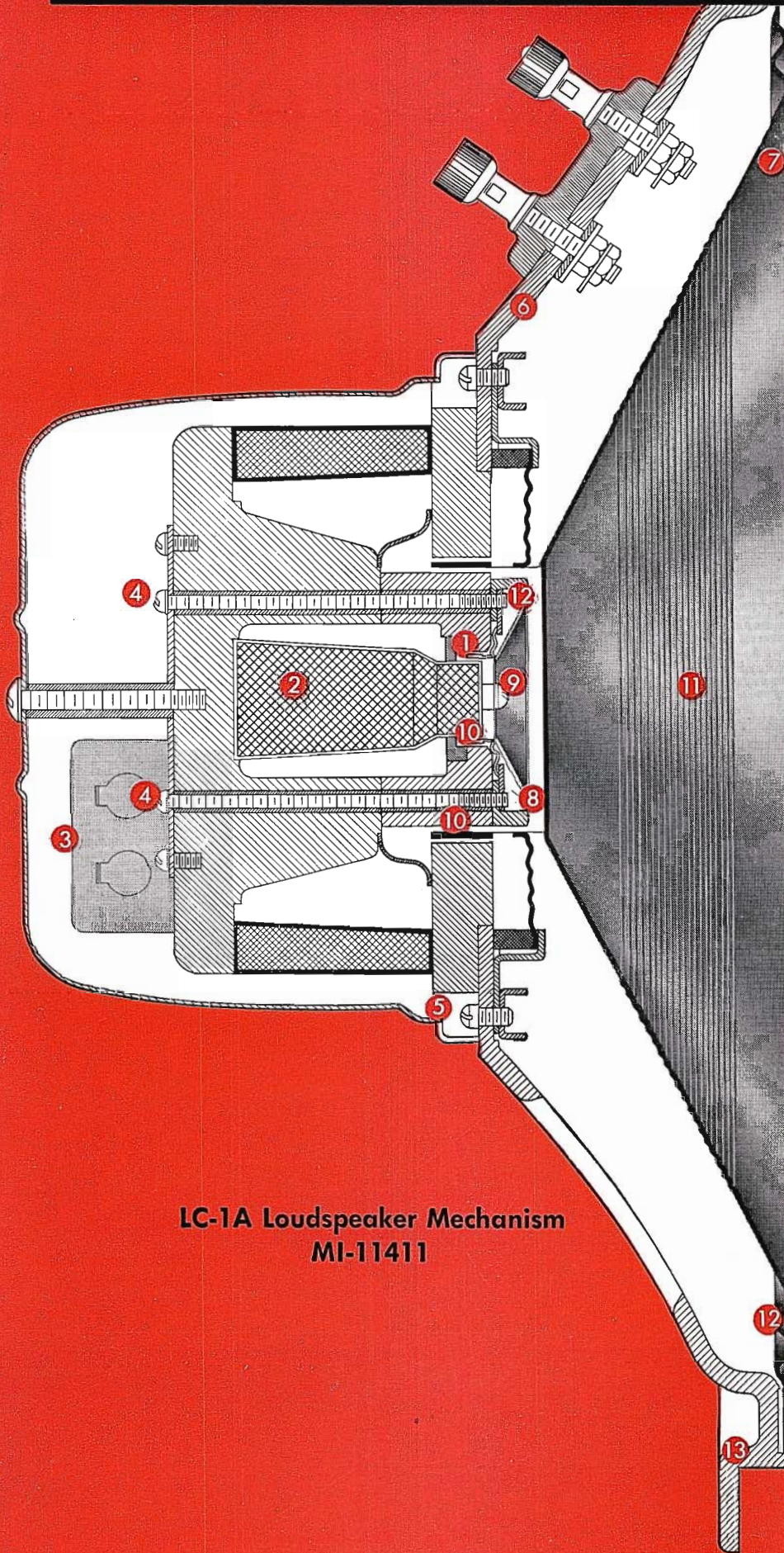

LC-1A Loudspeaker Mechanism  
MI-11411

1 H-f voice coil, aluminum wire-wound, to deliver full h-f range

2 Heavy ALNICO V magnets

3 Cross-over condenser

4 Centering adjustment for h-f cone

5 Centering adjustment for l-f cone

6 Sturdy die-cast aluminum frame

7 Shallow cone for smooth response and greater angle of distribution

8 H-f and l-f cones coaxially-mounted, mechanically independent

9 H-f cone. Diaphragm diameter only 2 $\frac{3}{8}$ ". Wide-angle distribution to 15,000 cycles

10 Ample gap clearances

11 Massive 15" l-f cone. Bass response 35 to 2000 cycles at all volume levels

12 Cone rim treated to minimize edge reflections for smoother response

13 Offset mount eliminates front cavity —insures smooth response



..... **next to perfect!**

# The Famous LC-1A Speaker

Among the great achievements of the RCA Princeton Laboratories is the development of the most advanced speaker in the world — the RCA Duo-Cone, Type LC-1A.

Expressly designed to give sound its true translation, this professional speaker is matched by no other high-quality sound reproducer.

Unique duo-cone design (originated by Dr. H. F. Olson of RCA Princeton Labs) provides a smooth response from 50 to 15,000 cycles — with no resonant peaks, harmonics, or transient distortion. Full power is radiated over 120-degrees at 15,000 cycles — makes it possible to enjoy high-fidelity sound *any place in the room!* Smooth crossover response around 2000 cycles eliminates all undesirable interference between the high-frequency unit and the low-frequency unit. Controllable "roll-off" at 5 and 10 kc... when used with the MI-11707 filter... restricts the h-f distortion and surface noises present in many recordings.

Today, more than 3000 of these speakers are serving in station control rooms, listening rooms, auditioning booths, lobbies, clients' offices, and private homes.

For more information, mail the coupon.

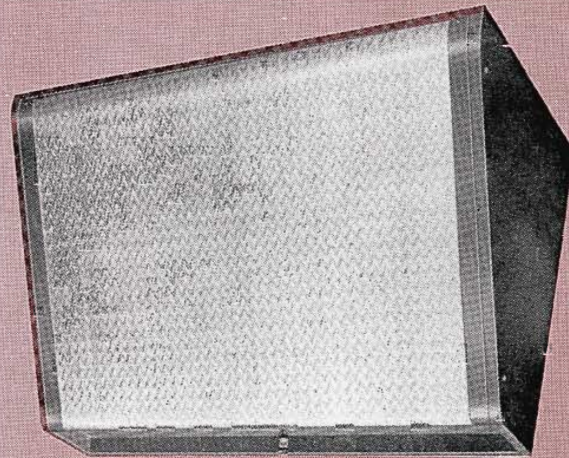

### New Wall-Ceiling Housing for LC-1A

Ideal for sound reinforcement in control rooms, auditioning booths, hallways, talkback positions, elevators,

executive offices. Port provided for increasing bass response. Finished in harmonizing 2-tone umber gray.

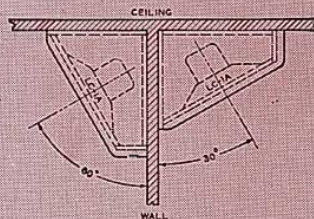

### It's Easy to mount

The Wall-Ceiling Housing can be mounted for long or short "throws" — makes the wall and ceiling a part of the acoustical system.

### The LC-1A Monitoring Speaker, with Console cabinet and MI-11707 filter

The finest reproducer in the business. Available in a choice of 2-tone umber gray or walnut finish.

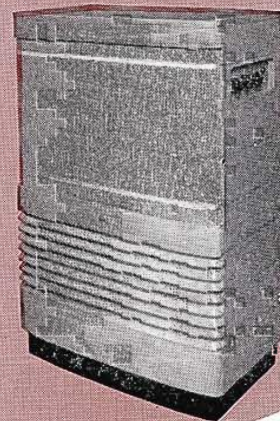

**AUDIO BROADCAST EQUIPMENT**  
**RADIO CORPORATION of AMERICA**  
ENGINEERING PRODUCTS DEPARTMENT, CAMDEN, N.J.

In Canada: RCA VICTOR Company Limited, Montreal

Department 19-IC,  
RCA Engineering Products  
Camden, N. J.

Send me price and information on

- LC-1A Speaker Mechanism, MI-11411
- LC-5A Wall-Ceiling Cabinet, MI-11406
- LC-1A Speaker with Console Cabinet, MI-11411/11401

Name \_\_\_\_\_

Station or firm \_\_\_\_\_

Address \_\_\_\_\_

City \_\_\_\_\_ State \_\_\_\_\_

# NEW

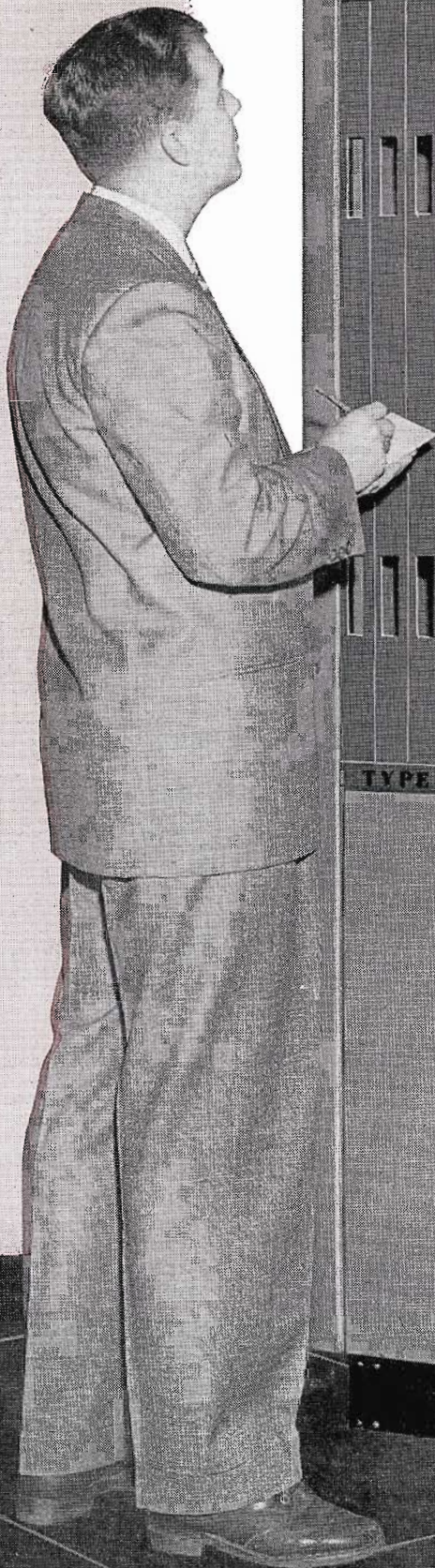

● Takes 7½ sq. ft. of operating floor space — less than half that of most "1-kw's"

● The only "1-kw" with sliding doors — saves over 12½ sq. ft. of operating floor area

● Uses only 4 different tube types — less than half the number used by most "1-kw's"

● Easiest to tune — only one tuning control in entire transmitter

● Low power consumption (3500 watts input at average program level)

Broadcasting's smallest "1-kw" AM, Type BTA-1M. It is completely self-contained! Note new sliding door construction.

# 1-KW AM

**...half the size... better performance**

AGAIN, RCA Broadcast Engineering sets the pace—with a superior "1-kw" that takes less floor space *than any 1-kw AM model now available*. Operation is reduced virtually to "switching on" and "switching off." Running expense is next to nothing.

Unlike "warmed over" versions of conventional broadcast transmitters, Type BTA-1M is totally new—from input to output. For example: New type horizontal sliding doors that never extend beyond the cabinet,

front or rear—save more than 12½ square feet of operating floor space • One tuning control for the entire transmitter • One power output control • Only 15 tubes used throughout (just 4 types to stock) • The one and only 1-kw AM with an all-aluminum cabinet (transmitter weighs less than half as much as other modern 1-kw's).

Type BTA-1M is ready for immediate shipment. Ask your RCA Sales Representative for complete details!

New, easy-to-reach vertical control panel. Just slide front door to left 4 inches (to automatic stop point). Transmitter interior not accessible until door is moved further left beyond this stop position—when interlocks and grounding switches function.

Matching cabinet(s) are available to house antenna phasing and branching equipment — if your station operates with a directional array.

Rear sliding door design gives operator more elbow room.

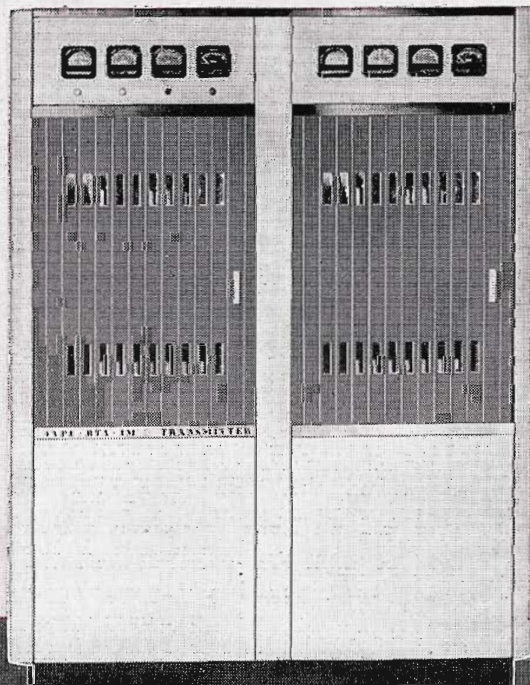

**RADIO CORPORATION of AMERICA**  
ENGINEERING PRODUCTS DEPARTMENT

CAMDEN, N.J.

Hinged front panel—and "Swing-up" amplifier frame make all underside components easily accessible.

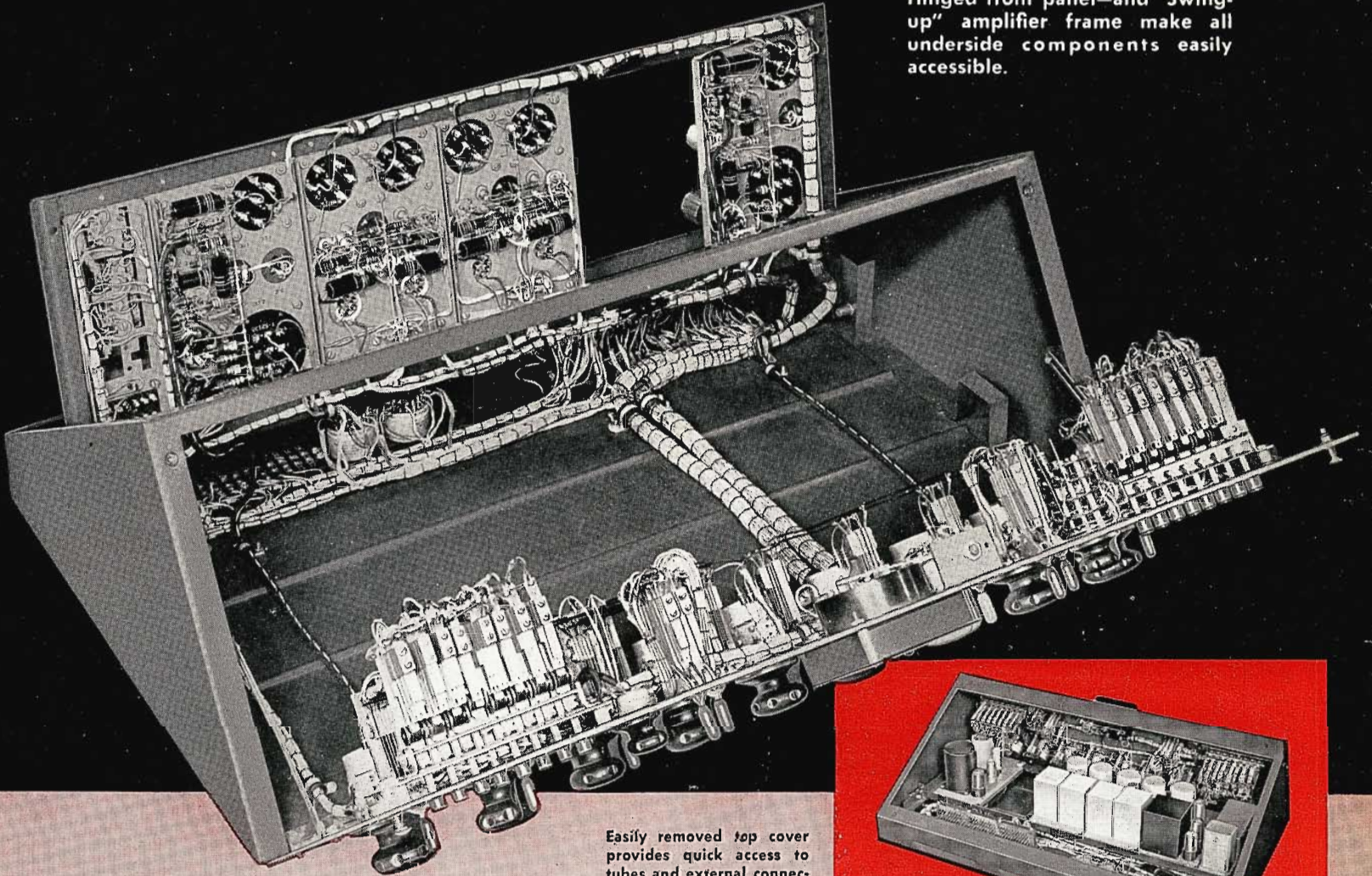

Easily removed top cover provides quick access to tubes and external connections. The BC-2B will fit snug against the studio window.

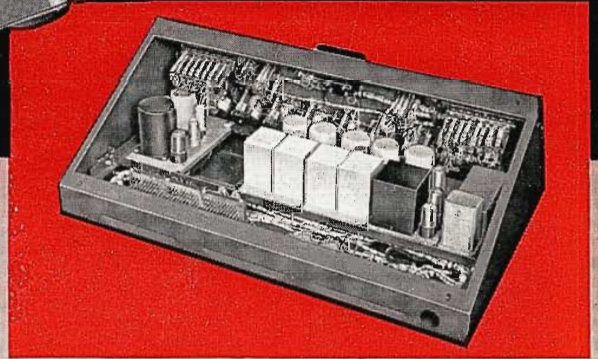

# NEW DESIGN *consolette*

## Color coded for "error-proof" control

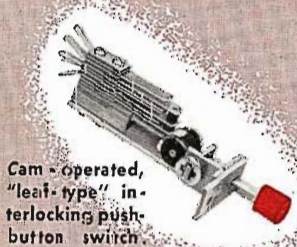

Cam-operated, "leaf-type" interlocking push-button switch.

The new consolette BC-2B provides all the essential audio facilities needed by most AM, FM, and TV stations—plus many extra operating advantages not previously available in a standard consolette. It speeds up switching operations substantially over previous

designs. It provides for complete control of all studio operations. *The BC-2B gives your station "deluxe" features at a "standard" price.*

Read the list of exclusive "extra" features the new BC-2B offers you. Then ask your RCA Broadcast Sales Representative for complete details. His service is as near as your phone.

### 11 extra features!

- "Color-coded" controls quickly identify and tie related functions together.
- New, leaf-type cam-operated interlocking, push-button switches.
- New hinged front panel for easy access to switches, gain controls, and contacts.
- Amplifiers mounted on "swing-up" frame; chassis easy to remove.
- New 30° sloping top panel for maximum studio visibility—styling compatible with modern AM and TV practice.
- New compact amplifiers use low-noise, long-life, miniature tubes.
- Improved, faster-operating speaker relays eliminate key clicks and audio feedback.
- Lamp dimmer for VU meter (Ad. for TV service).
- 8 high-level mixing channels, separate gain controls for network and airside.
- Turntable mixers with "built-in" cueing switches.
- No clearance required at rear—can be installed up against wall and control room window. Uses less desk space, too.



**RADIO CORPORATION of AMERICA**  
ENGINEERING PRODUCTS DEPARTMENT

CAMDEN N.J.